

RESM-5

Operating Instructions



Important features

- Microprocessor technology
- OLED display (yellow / green), 4 lines, 20 characters (multilingual)
- Automatic zero calibration (AUTOCAL)
- Automatic configuration of the secondary voltage and current ranges (AUTORANGE)
- Diagnostic interface for the PC visualization software
- Automatic frequency adjustment
- Heatsealing band alloy and temperature range selectable
- Configurable alarm output
- Configurable RESET input
- 0...10VDC analog output for ACTUAL temperature, electrically isolated
- 24VDC control inputs for AUTOCAL and ALARM-IN/RESET, electrically isolated
- Alarm function with error diagnosis

Functionally compatible with the RESM-4

Contents

1	Safety and warning notes	3	9	Unit functions	22
1.1	Use	3	9.1	LEDs and controls	22
1.2	Heatsealing band	3	9.2	Display	23
1.3	Impulse transformer	3	9.3	Navigation in the menus	24
1.4	Current transformer PEX-W2/-W3	3	9.4	Menu structure	26
1.5	Line filter	4	9.5	Menu steps	28
1.6	Standards / CE marking	4	9.6	Monitoring temperature setting (maximum temperature set point)	31
1.7	Warranty provisions	4	9.7	Temperature indication / actual value output	31
2	Application	4	9.8	Automatic zero calibration (AUTOCAL)	32
3	Basics of temperature control / measurement	5	9.9	"ALARM-IN/RESET" signal	33
3.1	Problem	5	9.10	AUTOCAL function disabled	33
3.2	Basics	6	9.11	Temperature unit Celsius / Fahrenheit	34
3.3	Fault causes	7	9.12	Disable Configuration menu	34
3.4	Measures to reduce the risk of overheating	8	9.13	Display brightness	35
3.5	Possible faults and how to detect them	9	9.14	Undervoltage detection	35
3.6	Residual risks	10	9.15	Unit information	35
4	Accessories and modifications	11	9.16	Diagnostic interface / visualization software	36
4.1	Accessories	11	9.17	System monitoring / alarm output	36
4.2	Modifications (MODs)	11	9.18	Error messages	37
5	Technical data	12	9.19	Fault areas and causes (main RESIS- TRON controller)	41
6	Dimensions	13	10	Factory settings	43
7	Installation	14	10.1	Customer settings	44
7.1	Installation procedure	14	11	Maintenance	44
7.2	Installation steps	15	12	How to order	45
7.3	Wiring diagram	17	13	Index	46
7.4	Power supply	18			
8	Startup and operation	18			
8.1	View of the unit	18			
8.2	Unit configuration	18			
8.3	Heatsealing band	20			
8.4	Startup procedure	20			
8.5	Basic functional test on the RESM-5	22			

1 Safety and warning notes

This RESISTRON temperature controller is manufactured according to DIN EN 61010-1. In the course of its manufacture it passed through quality assurance, whereby it was subjected to extensive inspections and tests.

It left the factory in perfect condition.

The recommendations and warning notes contained in these operating instructions must be complied with, in order to guarantee safe operation.

The device can be operated within the limits indicated in the "Technical Data" without impairing its operational safety. Installation and maintenance may only be performed by technically trained, skilled persons who are familiar with the associated risks and warranty provisions.

1.1 Use

RESISTRON temperature controllers may only be used for heating and temperature control of heatsealing bands which are expressly suitable for them, and providing the regulations, notes and warnings contained in these instructions are complied with.

 **In case of non-compliance or use contrary to the intended purpose, there is a risk that safety will be impaired or that the heatsealing band, electrical wiring, transformer etc. will overheat. Ensuring such compliance is the personal responsibility of the user.**

1.2 Heatsealing band

A basic prerequisite for reliable and safe operation of the system is the use of suitable heatsealing bands.

 **The resistance of the heatsealing band which is used must have a positive minimum temperature coefficient in order to guarantee trouble-free operation of the RESISTRON temperature controller.**

The temperature coefficient must be specified as follows:

$$TCR \geq 10 \times 10^{-4} \text{K}^{-1}$$

e.g. Alloy A20: TCR = 1100 ppm/K
LEX3500: TCR = 3500 ppm/K

The RESISTRON temperature controller must be set and coded according to the temperature coefficient of the heatsealing band.

 **The use of incorrect alloys with a too low temperature coefficient and incorrect coding of the RESISTRON temperature controller lead to uncontrolled heating and ultimately to burn-out of the heatsealing band!**

The heatsealing bands that were originally supplied must be identified by detail specification, part number or some other means that will assure that replacement bands are identical.

1.3 Impulse transformer

A suitable impulse transformer is necessary to ensure that the control loop functions perfectly. This transformer must be designed according to VDE 0570/EN 61558 (isolating transformer with reinforced insulation) and have a one section bobbin. When the impulse transformer is installed, suitable shock protection must be provided in accordance with the national installation regulations for electrical equipment. In addition, water, cleaning solutions and conductive fluids must be prevented from seeping into the transformer.

 **Incorrect installation of the impulse transformer impairs electrical safety.**

1.4 Current transformer PEX-W2/-W3

The current transformer supplied with the RESISTRON temperature controller is an integral part of the control system.

 **Only the original ROPEX PEX-W2 or PEX-W3 current transformer may be used. Other transformers may cause the equipment to malfunction.**

The current transformer may only be operated if it is connected to the RESISTRON temperature controller correctly (see section 9, "Startup and operation"). The relevant safety instructions contained in section 8.3, "Power supply", must be obeyed. External monitoring modules can be used in order to additionally increase

operating safety. They are not included in the scope of supply of the standard control system and are described in a separate document.

1.5 Line filter

The use of an original ROPEX line filter is mandatory in order to comply with the standards and provisions mentioned in section 1.6 "Standards / CE marking" on page 4. This device must be installed and connected according to the instructions contained in section 8.3, "Power supply" as well as the separate documentation enclosed with the line filter.

1.6 Standards / CE marking

The controller described here complies with the following standards, provisions and directives:

DIN EN 61010-1:2001 (2006/95/EG)	Safety requirements for electrical equipment for measurement, control and laboratory use (low-voltage directive): pollution degree 2, protection class II, measurement category I (for U _R and I _R terminals)
DIN EN 60204-1 (2006/42/EG)	Electrical equipment of machines (machinery directive)
EN 55011:1998 + A1:1999 + A2:2002 EN 61000-3-2:2006-04 EN 61000-3-3:1995-01 + A1:2001 + A2:2005-11 (2004/108/EG)	EMC genery emissions: Group 1, Class A
EN 61000-6-2:2005 (2004/108/EG)	EMC generic immunity: Class A (ESDs, RF radiation, bursts, surges) <u>Exception:</u> Line voltage interruption acc. EN 61000-4-11 is not fulfilled (This leads to a designated error message of the controller)

2 Application

If the RESISTRON controller circuit is analyzed in detail, it is clear that a whole series of hardware faults could conceivably result in dangerous conditions, for instance because they cause the heatsealing band to overheat but are not detected by the standard alarm function. Even if most of these hardware faults are very

unlikely to occur, such failures can never be completely ruled out.

A redundant measuring system, the RESM-5, is therefore essential to monitor the complete controller, including the current transformer.

The RESISTRON monitoring device RESM-5 is connected to an existing RESISTRON control system

Compliance with these standards and provisions is only guaranteed if original accessories and/or peripheral components approved by ROPEX are used. If not, then the equipment is operated on the user's own responsibility.

The CE marking on the controller confirms that the device itself complies with the above-mentioned standards.

It does not imply, however, that the overall system also fulfils these standards.

It is the responsibility of the machine manufacturer and of the user to verify the completely installed, wired and operationally ready system in the machine with regard to its conformity with the safety provisions and the EMC directive (see also section 8.3, "Power supply"). If peripheral components (e.g. the transformer or the line filter) from other manufacturers are used, no functional guarantee can be provided by ROPEX.

1.7 Warranty provisions

The statutory provisions for warranties apply for a period of 12 months following the delivery date.

All devices are tested and calibrated in the factory. Devices that have been damaged due to faulty connections, dropping, electrical overloading, natural wear, incorrect or negligent handling, chemical influences or mechanical overloading as well as devices that have been modified, relabeled or otherwise altered by the customer, for example in an attempt to repair them or install additional components, are excluded from the warranty.

Warranty claims must be examined in the factory and approved by ROPEX.

(any RESISTRON controller in the "400" or "5000" series with an alarm output); it measures the resistance of the heatsealing band and indicates the temperature in parallel operation using a separate current transformer.

The RESM-5 is connected to the line voltage in phase with the main controller. The measuring voltage U_R is drawn from the main controller for practical reasons

while the current transformer signal I_R is supplied by a separate current transformer.

A variable limit function is used to monitor the maximum temperature; an alarm (fault) is indicated at the alarm output of the RESM-5 if the limit value is exceeded.

⚠ To prevent dangerous situations, refer to the risk analysis for the machine or plant.

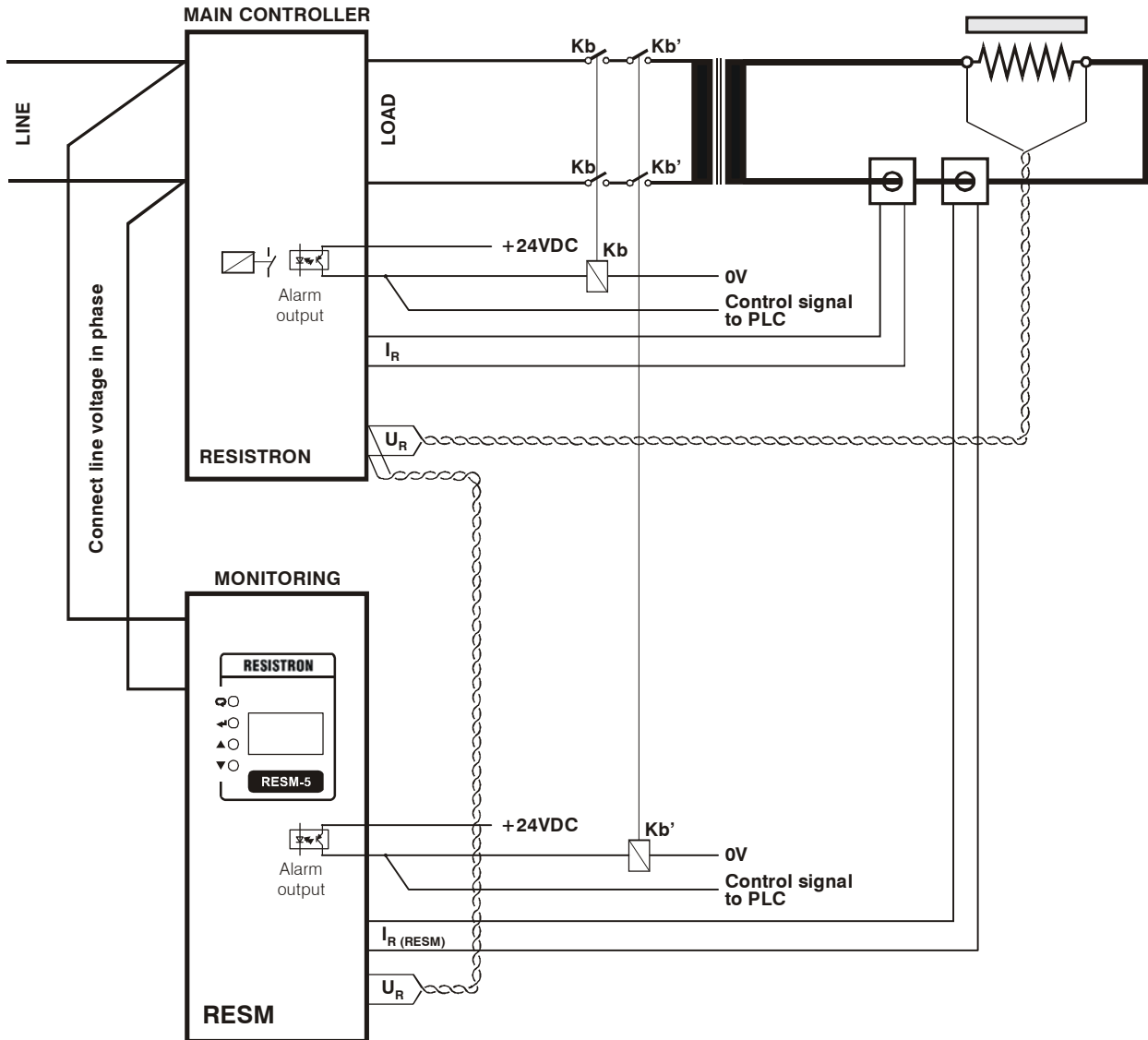

3 Basics of temperature control / measurement

The following section starts by outlining the possible causes of unwanted overheating when the temperature of a heatsealing band is controlled according to the resistance principle.

3.1 Problem

When the temperature of a heatsealing band is controlled according to the resistance principle, the band acts both as a heat source and as a temperature sensor. The heatsealing band supplies a unique

resistance value for each temperature based on its alloy-specific TCR (temperature coefficient of resistance).

This value may be altered by external impacts such as partial short-circuits, contacting problems, changed cross sections etc., i.e. the controller measures an incorrect resistance and responds by increasing or reducing the heating current, depending on the direction of the change, in an attempt to "follow" this false set point. Major deviations from the temperature set point are often attributable to faults such as these. Whereas an increase in the measured resistance (narrower cross section due to physical damage,

detached or corroded clamps, worn copper plating) simply leads to a harmless reduction in the actual heatsealing band temperature, a partial short-circuit (ground fault, conductive foreign particles, physical contact between two heatsealing bands) can cause the temperature of the band sections which are still active to rise significantly. Dangerous levels involving a risk of fire or explosion can then occur very quickly.

Depending on the design, execution, and wiring of the heatsealing tools and the interconnection of the heatsealing bands, numerous potential fault causes can thus be identified.

3.2 Basics

The diagram below is an electrical schematic of a sealing bar showing the heatsealing band and the power and measurement cables.

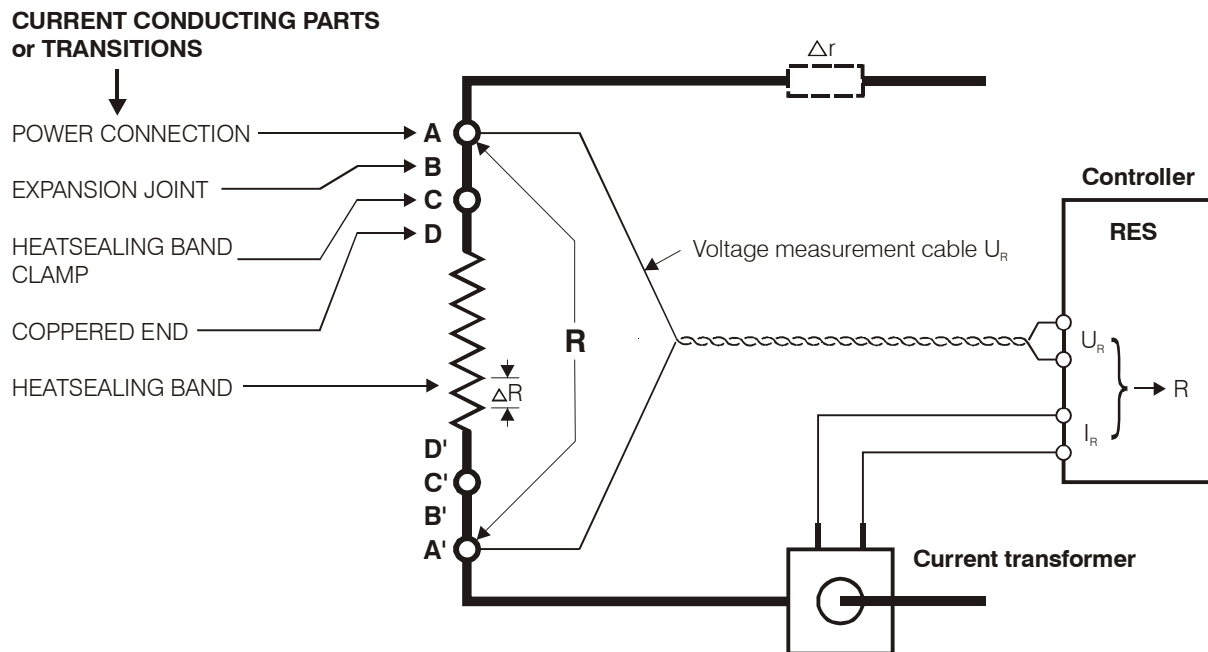

Note:

The term "measured resistance" or "resistance measured by the controller" is used in this document to refer to the resistance between two connection points A - A' on the voltage measurement cable U_R . In the diagram on page 6 this is the resistance R.

Only resistance faults which occur between the measuring points ΔR A - A' are relevant for the overheating problems described here. External faults Δr are not visible to the controller and are therefore not important for our purposes.

If the actual temperature of a heatsealing band in a closed control loop deviates from the set point, the following relationship is true:

$$\Delta T = -\frac{\Delta R}{R} \cdot \frac{1}{TCR} \quad (1)$$

$$\Delta T = T_{HL} - T_{Set} \quad (2)$$

In other words, the temperature error ΔT depends on the relative resistance change (due to the fault) and the temperature coefficient (TCR) of the resistor material. The temperature error ΔR can be either positive or negative depending on the sign of the fault (higher or lower resistance) ΔT .

The temperature error for the standard heatsealing band alloy where $TCR = +10 \cdot 10^{-4} \text{K}^{-1}$ is thus as follows:

$$\Delta T = 1000 \cdot \left(-\frac{\Delta R}{R}\right) [\text{K}] \quad (3)$$

This relationship is easily explained with the help of an example:

If the heatsealing band is "shortened" 20% electrically ($\frac{\Delta R}{R} = -0,2$) (e.g. by inserting a conducting part), the temperature error according to (3) is +200K.

In this case, the actual heatsealing band temperature according to (2) is as follows:

$$T_{HL} = \text{Set point} + 200\text{K}$$

It is clear from this example that a control system which operates according to the resistance principle responds extremely sensitively to heatsealing band resistance faults or faults in the associated electromechanical components.

The diagram on page 6 shows how the components A, B, C, and D belonging to the power cable are potential fault sources, for instance, because any change in the contact resistances distorts the resistance measured by the controller.

3.3 Fault causes

If all of the components belonging to the control loop are analyzed with respect to possible faults that could lead to dangerous overheating, several potential causes can be identified, e.g.:

- Contact between two heatsealing bands wired in series
- Ground fault
- Partial short-circuit
- Non-coppered heatsealing band ends
- Unsuitable heatsealing band alloy ($TCR = 0$ or too low)
- Defect in the measuring circuit of the controller electronics
- Defect in the power unit of the controller, e.g. triac remains conductive without an ignition signal
- Short circuit in the external wiring such that the triac is bypassed
- Defect in the current transformer
- Short circuit or break in the current or voltage measurement cables (U_R)
- Operator error
- etc.

Sudden resistance changes which are so large that the measured resistance is outside of the operating range (below zero or above 300°C / 500°C) can be detected and indicated by the controller.

On the other hand, smaller resistance steps or gradual changes cannot be detected as faults owing to the operating principle of the unit, so that the above-mentioned temperature deviations occur.

Some of the faults described here can be measured by RESISTRON controllers with an alarm function.

Others are detected by the RESISTRON monitoring device (RESM-5) and the MSW (refer to the separate documentation).

Even these two monitoring units are still unable to detect a few fault types (↪ section 3.6 "Residual risks" on page 10).

3.4 Measures to reduce the risk of overheating

As in any mechanical engineering application, safety aspects must be taken into account in the heatsealing system from the design stage onward. If this rule is observed, the majority of faults are prevented from the outset.

This document cannot provide detailed design instructions for sealing tools; only a few particularly important points are mentioned here as a reminder:

Heatsealing band

- Use a heatsealing band with the specified TCR
- Copper the ends at least 10 mm into the bar
- Protect the coppered ends with a layer of nickel or gold if there is a risk of corrosion

Bar end blocks (the heatsealing band's expansion joints)

- Electrically insulated at both ends
- Tightened at both ends
- Sufficient spring force, unrestricted movement
- Heatsealing band tightly clamped

- Power connection tightly clamped
- No current flowing through moving parts (pivot pins etc.)
- Carefully executed insulation

Bars

- Flat bars, not warped
- Carefully executed insulation of the heatsealing band

Electrical wiring

- Use cables with an adequate cross section (☞ ROPEX Application Report)
- Use short cables where possible
- Use only plug connectors that conform to ROPEX specifications ("Basics" documentation)
- Use separate connections to attach the measurement cables to the bar end blocks
- etc.

 **To prevent dangerous situations, refer to the information provided in the ROPEX Application Report and the risk analysis for the machine or plant.**

3.5 Possible faults and how to detect them

Possible fault	Detected with		
	RESISTRON controller ("400" or "500" series) with alarm output	Additional monitoring current transformer MSW	Additional, redundant RESISTRON monitoring device RESM-5
Heatsealing band break	Yes	No	Yes
I_R and U_R measurement cables (break or short circuit)	Yes	No	Yes
Contact between two heatsealing bands (wired in series)	Possibly ¹	Yes	No
Heatsealing band partially short-circuited	Possibly ¹	No	No
Ground fault	No	Yes	No
Zero point suppression due to incorrect calibration	Yes	No	Yes
Controller hardware defect	No	No	Yes
Triac conductive or bypassed	Yes	No	Yes
Current transformer defect	No	No	Yes
Heatsealing band with too low a TCR (↪ section 3.6 "Residual risks" on page 10)	No	No	No

1. If the measured resistance of the heatsealing band changes >10%

3.6 Residual risks

Even if the RESISTRON monitoring device RESM-5 (and the optional monitoring current transformer MSW) are used, there are still a few operating states that can cause undetected overheating of the heatsealing band. Some of these fault causes have already been described in detail above.

They are summarized again below:

- Non-coppered heatsealing band ends
- Heatsealing band with no TCR or a TCR that is too low
- Conductive, ungrounded part which partially short circuits the heatsealing band during the heating phase

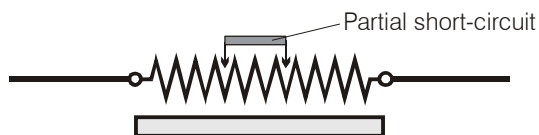

Consequence: The controller measures a lower resistance and continues heating to a higher temperature.

- Reduction in the resistance measured by the controller (between the two connection points on the voltage measurement cable U_R) during the heating phase (similar effect to that described above but a different cause)

Example:

The clamp for the heatsealing band connection

makes poor contact (loose contact) → contact resistance.

The sealing tool is open, the heatsealing band is cold, and the controller is calibrated using the AUTOCAL function.

The tool closes and the controller heats up.

The contact with the heatsealing band improves under the closing pressure, the resistance is reduced, and the controller heats to a higher temperature.

In other words:

The zero point is calibrated when the circuit has high impedance.

The circuit has lower impedance during the heating phase.

Consequence: Overheating

- Physical damage to the heatsealing band (contraction, cracking etc.) leading to a narrower cross section
The heatsealing band overheats at this point (HOT SPOT). It can glow red-hot as a result.
- The resistance increase which occurs here is so small in relation to the total resistance that it cannot be detected by the controller in practice.
- Incorrect operation
Example: AUTOCAL is run when the heatsealing band is hot
- Design error regarding the installation and wiring of the control and monitoring system.
Remedy: Check regularly that the monitoring system is working correctly by deliberately inducing short circuits, breaks etc. (checklist).

4 Accessories and modifications

A wide range of compatible accessories and peripheral devices are available for the RESISTRON monitoring device RESM-5. They allow it to be optimally adapted to your specific heatsealing application as well as to your plant's design and operating philosophy.

4.1 Accessories

- The products described below are only a few of the wide range of accessories available for RESISTRON monitoring devices (☞ "Accessories" leaflet).

	<p>Analog temperature meter ATR-x For front panel mounting or mounting on a top hat rail (DIN TS35 rail). Analog indication of the ACTUAL temperature of the heatsealing band in °C. The meter damping of the unit is optimized for the abrupt temperature changes that occur in impulse mode.</p>
	<p>Line filter LF-xx480 Essential to ensure CE conformity. Optimized for the RESISTRON monitoring device.</p>
	<p>Communication interface CI-USB-1 Interface for connecting a RESISTRON monitoring device with a diagnostic interface (DIAG) to the PC (USB port). Associated PC visualization software for displaying setting and configuration data as well as for recording SET and ACTUAL temperatures in real time.</p>
	<p>Monitoring current transformer MSW For detecting frame short-circuits on the heatsealing band. Used as an alternative to the standard PEX-W2 / W3 current transformer.</p>
	<p>U_R measurement cable UML-1 Twisted cable for measuring the U_R voltage. Suitable for drag chains, contains neither halogens nor silicone.</p>

4.2 Modifications (MODs)

Owing to its universal design, the RESISTRON monitoring device RESM-5 is suitable for a very wide range of heatsealing applications.

Modifications (MODs) are available for the RESISTRON monitoring device RESM-5 for implementing special applications.

MOD 01

Booster for low secondary voltages ($U_R = 0.25...16VAC$). This modification is necessary, for example, for very short or low-resistance heatsealing bands.

5 Technical data

Type of construction	Housing for installation in the electrical cabinet Snaps onto a standard top hat rail (DIN TS35 rail, 35mm) acc. to DIN EN 50022 Dimensions: 90 x 75mm; height: 135 mm (incl. terminals)
Line voltage	115VAC version: 110VAC -15%...120VAC +10% (equivalent to 94...132VAC) 230VAC version: 220VAC -15%...240VAC +10% (equivalent to 187...264VAC) 400VAC version: 380VAC -15%...415VAC +10% (equivalent to 323...456VAC) Depending on the version selected (↪ section 12 "How to order" on page 45)
Power supply system	Balanced TN or TT system, max. 415VAC Installation category III  Operation in potential-free systems (e.g. an IT system) is only permitted after consultation with ROPEX.
Line frequency	50 / 60Hz (47...63Hz, automatic adjustment to frequencies in this range)
Auxiliary voltage Terminals 12+13	24VDC, +20%, -10%, protected against reverse polarity Max. current input: 1.0A
Measuring range	Secondary voltage U_R : 0.4...120VAC Secondary current I_R : 30...500A (with PEX-W2/-W3 current transformer) ↪ ROPEX Application report
Heatsealing band type and temperature range	The temperature range and temperature coefficient settings can also be specified independently of one another in the Configuration menu: Temperature range: 200°C, 300°C, 400°C, or 500°C Temperature coefficient: 400...4000ppm/K (variable setting range)
Analog output (actual value) Terminals 17+14	0...10VDC, $I_{max} = 5\text{mA}$, electrically isolated Equivalent to 0...300°C or 0...500°C Accuracy: $\pm 1\%$ plus 50mV
Digital logic levels Terminals 5, 6, 7	LOW (0V): 0...2VDC, electrically isolated HIGH (24VDC): 12...30VDC (max. current input: 6mA) Protected against reverse polarity
Alarm output Terminal 18	$U_{ON} < 3\text{V}$ (saturation voltage), $I_{max} = 200\text{mA}$, electrically isolated, short-circuit proof, can be inverted in the Configuration menu
Power dissipation	Max. 10VA
Ambient temperature	+5...+45°C
Degree of protection	IP20

7 Installation

↪ See also section 1 "Safety and warning notes" on page 3.

⚠ Installation and startup may only be performed by technically trained, skilled persons who are familiar with the associated risks and warranty provisions.

7.1 Installation procedure

Proceed as follows to install the RESISTRON monitoring device RESM-5:

1. Switch off the line voltage and verify that the circuit is de-energized.
2. The supply voltage specified on the nameplate of the RESISTRON monitoring device must be identical to the line voltage that is present in the plant or machine. The line frequency is automatically detected by the temperature controller in the range from 47Hz to 63Hz.

3. Install the RESISTRON monitoring device in the front panel cutout. It is fastened by means of two clips which snap onto the side of the controller housing.
4. Wire the system in accordance with the instructions in section 7.3 "Wiring diagram" on page 17, section 7.3 "Wiring diagram" on page 17, and the ROPEX Application Report. The information provided in section 7.2 "Installation steps" on page 15 must also be heeded.

⚠ Check the tightness of all system connections, including the terminals for the impulse transformer windings.

5. Make sure the wiring conforms to all relevant national and international installation regulations.

⚠ To prevent dangerous situations, refer to the risk analysis for the machine or plant.

7.2 Installation steps

7.2.1 RESM-5 and RESISTRON controllers with separate evaluation of alarms (recommended by ROPEX)

The RESISTRON monitoring device RESM-5 is a separate unit which should also be integrated as such in the plant or machine concept.

The alarm outputs of the main RESISTRON controller and the RESM-5 energize separate contactors or relays (Kb, Kb'). The alarm output signals are

additionally transferred to the PLC / machine control system as control signals. The alarm outputs of the RESM-5 and the main RESISTRON controller can be separately evaluated and tested in this way. The additional control signals to the PLC / machine control system enable both the status and the sequence of the alarms to be evaluated (e.g. an alarm indicated by the main RESISTRON controller results in an RESM-5 alarm). This wiring principle is shown in the diagram below.

! To prevent dangerous situations, refer to the risk analysis for the machine or plant.

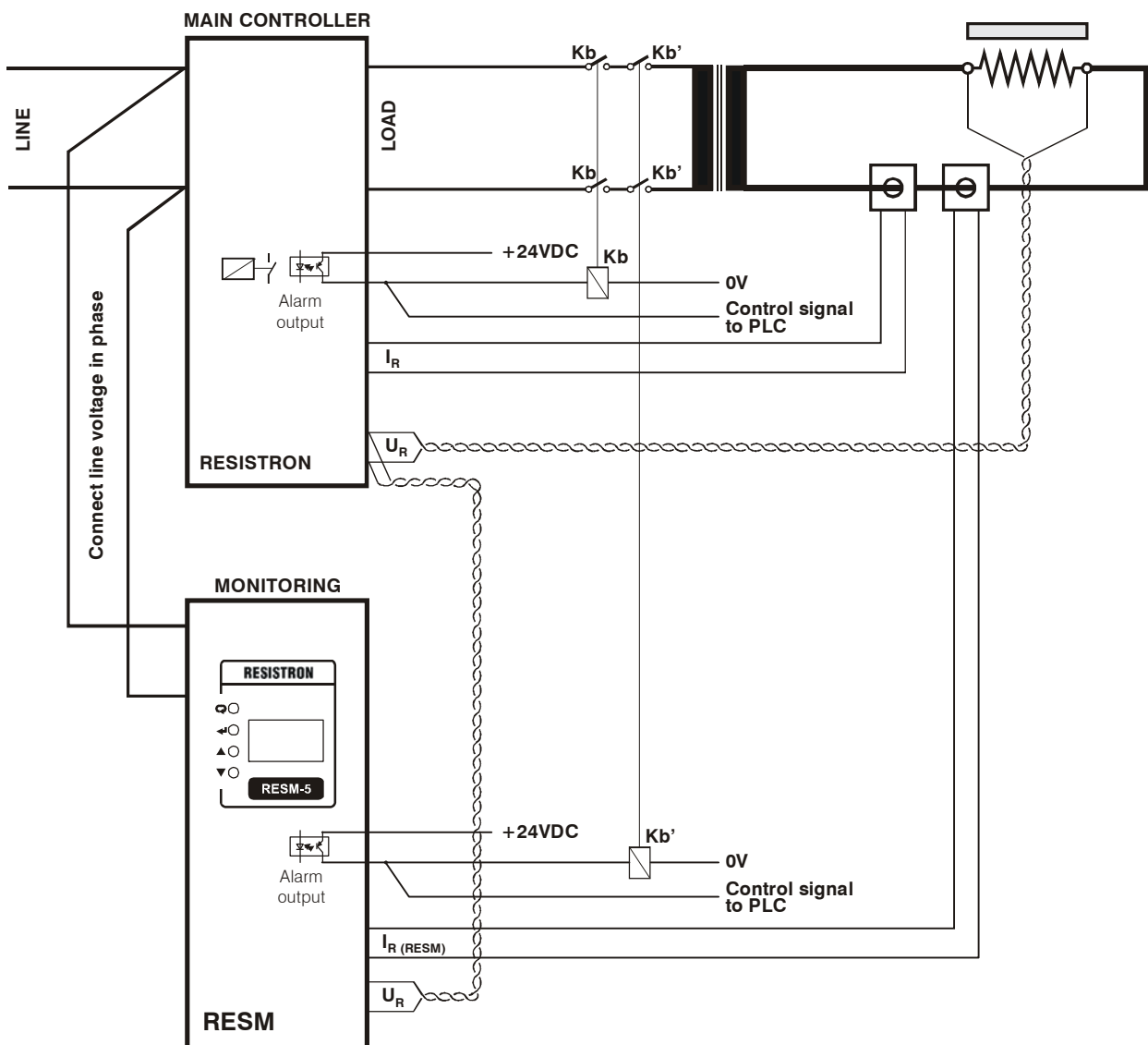

7.3 Wiring diagram

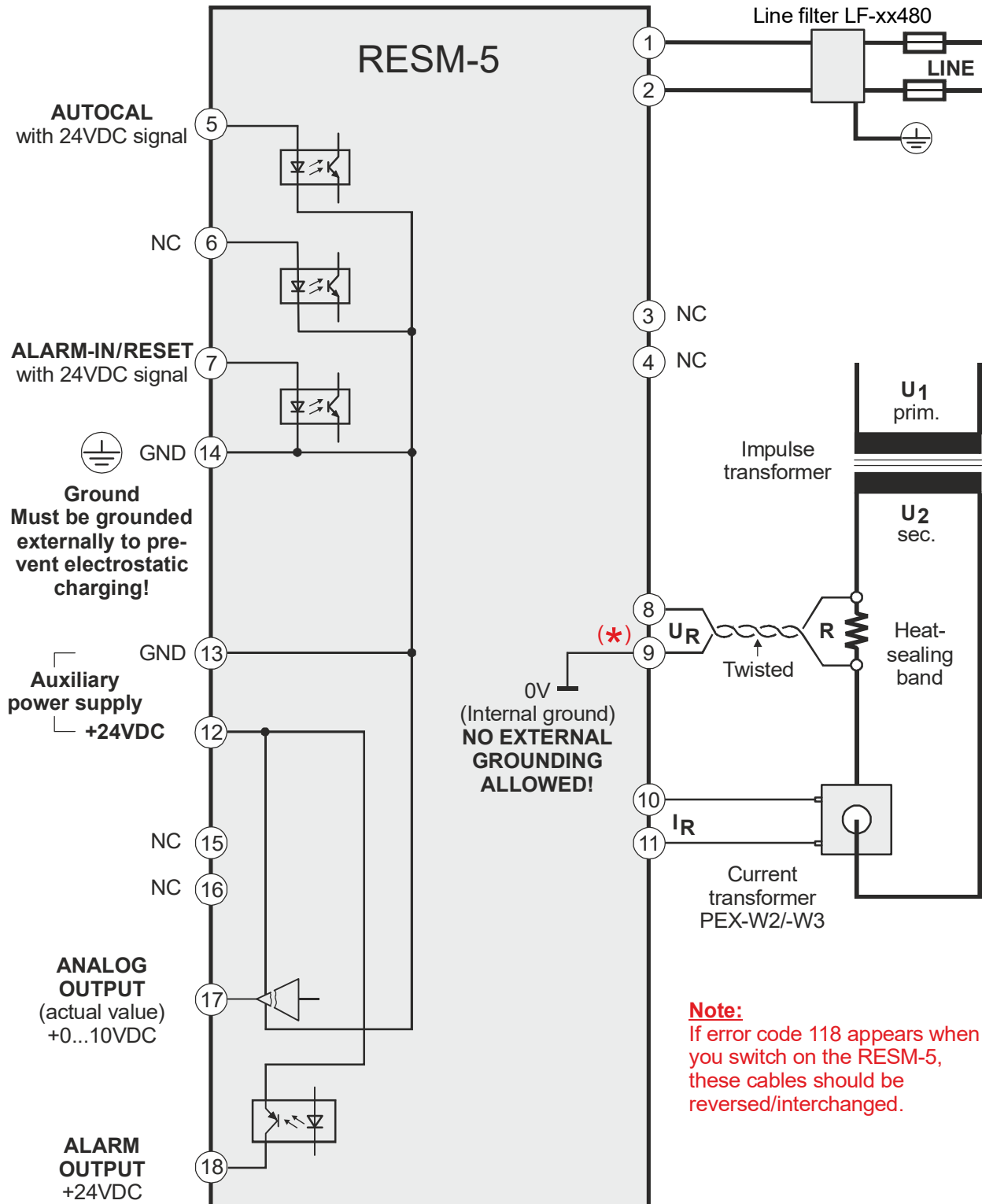

7.4 Power supply

Refer to the information in the “Power supply” section of the documentation for your temperature controller.

! The RESISTRON monitoring device and the temperature controller must both be connected to the same phases of the power supply. If not, they may no longer work correctly.

The RESISTRON monitoring device must be operated with an LF-xx480 line filter. It can either be equipped with a separate line filter or share the same filter as the temperature controller.

8 Startup and operation

8.1 View of the unit

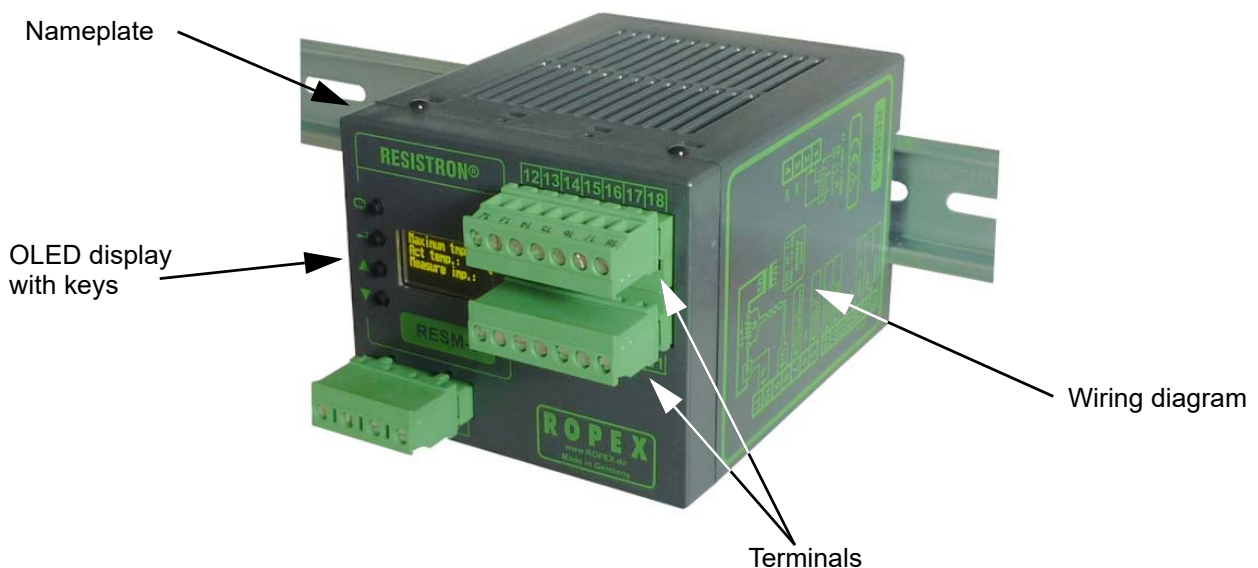

8.2 Unit configuration

The possible unit configurations are explained in the following sections. Proceed as described in section 8.4.1 "Initial startup" on page 20 to start up the unit for the first time.

8.2.1 Configuration of the secondary voltage and current ranges

The secondary voltage and current ranges are automatically configured by the automatic calibration function (AUTOCAL). The voltage is configured in the range from 0.4VAC to 120VAC and the current in the

range from 30A to 500A. If the voltage and / or current are outside of the permissible range, a detailed error message appears on the RESISTRON monitoring device (↪ section 9.18 "Error messages" on page 37). If the secondary current I_2 is less than 30A, the wire must be laid twice through the PEX-W2 or PEX-W3 current transformer (↪ ROPEX Application Report).



8.2.2 Menu language

The menu language can be changed while the RESISTRON monitoring device is operating. You set it with step 201 in the Configuration menu. The following settings are possible:

English, German

 **The language selected in this menu remains set if the factory settings are restored (step 202 in the Configuration menu).**

 **The language selected with step 201 can still be changed even if the Configuration menu is disabled (↪ section 9.12 "Disable Configuration menu" on page 34).**

8.2.3 Restoring the factory settings

The internal settings of the RESISTRON monitoring device can be reset to the factory defaults with step 202 in the Configuration menu. Only the language selected with step 201 in the Configuration menu remains unchanged.

Refer to section 10 "Factory settings" on page 43 for more information about the factory settings.

 **If the unit's settings are unknown when it is started up for the first time, you must restore the factory settings in order to prevent malfunctions.**

8.2.4 Configuration of the alloy (temperature coefficient)

The temperature coefficient for your particular heatsealing band can be individually set in the range from 400 to 4000ppm/K with step 204 in the Configuration menu.

 **To prevent dangerous situations, refer to the risk analysis for the machine or plant.**

8.2.5 Configuration of the temperature range

The temperature range for the RESISTRON monitoring device can be set with step 205 in the Configuration menu.

You can choose between 200°C, 300°C (factory setting), 400°C, and 500°C.

8.2.6 Configuration the maximum temperature (alarm threshold)

You set the maximum temperature with step 206 in the Configuration menu. If the measured heatsealing band temperature exceeds the maximum temperature specified here (alarm threshold), the RESISTRON monitoring device generates error code 109.

 **To prevent dangerous situations, refer to the risk analysis for the machine or plant.**

8.2.7 Configuration of the alarm output

You set the alarm output with step 215 in the Configuration menu. There are four possible settings:

1. **"normal" (factory setting)**
The alarm output is energized at alarm.
2. **"invers"**
The alarm output is de-energized at alarm.
3. **"normal w. RESET"**
The alarm output is energized at alarm or when the ALARM-IN/RESET input is energized.
4. **"inverse w. RESET"**
The alarm output is de-energized at alarm or when the ALARM-IN/RESET input is energized.

Other startup configuration options:

5. **"30sec. inactive"**
The alarm output is de-energized for 30 seconds regardless of any alarms.
6. **"1 min. inactive"**
The alarm output is de-energized for 1 minute regardless of any alarms.
7. **"5min inactive"**
The alarm output is de-energized for 5 minutes regardless of any alarms.

 **To prevent dangerous situations, refer to the risk analysis for the machine or plant.**

8.3 Heatsealing band

8.3.1 General

The heatsealing band is a key component in the control loop because it is both a heating element and a sensor. The geometry of the heatsealing band is too complex to be discussed at length here. We shall therefore only refer to a few of the most important physical and electrical properties.

The measuring principle applied for this system requires a heatsealing band alloy with a suitable temperature coefficient TCR, i.e. one whose resistance increases as the temperature rises.

Too low a TCR leads to oscillation or measurement errors.

If a heatsealing band with a higher TCR is used, the RESISTRON monitoring device must be calibrated for this.

The first time the heatsealing band is heated to approximately 200...250°C, the standard alloy undergoes a once-only resistance change (burn-in effect). The cold resistance of the heatsealing band is reduced by approximately 2...3%. However, this at first glance slight resistance change results in a zero point error of 20...30°C. The zero point must therefore be corrected after a few heating cycles (↪ section 8.3.2 "Replacing the heatsealing band" on page 20).

One very important design feature is the copper or silver-plating of the heatsealing band ends. Cold ends allow the temperature to be controlled accurately and increase the life of the Teflon coating and the heatsealing band.

 **An overheated or burned-out heatsealing band must no longer be used because the TCR has been irreversibly altered.**

8.3.2 Replacing the heatsealing band

All power supply leads must be disconnected from the RESISTRON monitoring device in order to replace the heatsealing band.

 **The heatsealing band must be replaced in accordance with the instructions provided by the manufacturer. To prevent dangerous**

situations, refer to the risk analysis for the machine or plant.

Each time the heatsealing band is replaced, the zero point must be calibrated with the AUTOCAL function while the band is still cold in order to compensate production-related resistance tolerances. The burn-in procedure described above should be performed for all new heatsealing bands.

8.4 Startup procedure

Please also refer to section 1 "Safety and warning notes" on page 3 and section 2 "Application" on page 4.

 **Installation and startup may only be performed by technically trained, skilled persons who are familiar with the associated risks and warranty provisions.**

8.4.1 Initial startup

Prerequisites: The unit must be correctly installed and connected (↪ section 7 "Installation" on page 14).

All possible settings are described in detail in section 8.2 "Unit configuration" on page 18 and section 9 "Unit functions" on page 22.

The essential configurations of the RESISTRON monitoring device are described below:

1. Switch off the line voltage and verify that the circuit is de-energized.
2. The supply voltage specified on the nameplate of the unit must be identical to the line voltage that is present in the plant or machine. The line frequency is automatically detected by the RESISTRON monitoring device in the range from 47 to 63Hz.
3. Make sure no START signal on the temperature controller is applied.
4. Switch on the line voltage.
5. A power-up message appears on the display for approximately 2 seconds when you switch on the monitoring unit to indicate that it is being powered up correctly.

6. One of the following states then appears:

DISPLAY	ACTION
Display in home position	Go to step 7
Error message with error code 104...106, 109, 111...113, 211	Go to step 7
Error message with error code 118	Reconnect/ Interchange U_R measuring wire to terminals 8+9. Then return to step 3
Error message with error code 101...103, 107, 108, 201...203, 801, 9xx	Error diagnosis (↪ section 9.18)

7. Configure the unit as described in section 8.2 "Unit configuration" on page 18. The following settings must always be configured:

Setting	Step in Configuration menu
Language	201
Restore factory settings	202
Temperature range and heatsealing band alloy	204, 205

8. Run the AUTOCAL function while the heatsealing band is cold (step 107 in the Settings menu or "AUTOCAL" signal, terminals 5+14). The progress of the calibration is indicated by a counter on the

8.4.2 Restart after replacing the heatsealing band

To replace the heatsealing band, proceed as described in section 8.3 "Heatsealing band" on page 20.

display (approx. 10...15 s). A voltage of 0VDC additionally appears at the actual value output (terminals 17+13). If an ATR-x is connected, it indicates 0...3°C.

When the zero point has been calibrated, the display returns to the home position and an actual value of 20°C is indicated. A voltage of 0.66VDC (300°C range) or 0.4VDC (500°C range, equivalent to 20°C), appears at the actual value output instead. If an ATR-x is connected, it must be set to "Z" (20°C).

If the zero was not calibrated successfully, an error message indicates error codes 104...106, 211. In this case the RESM-5 configuration is incorrect (↪ section 8.2 "Unit configuration" on page 18 and ROPEX Application Report). Repeat the zero point calibration after the unit has been configured correctly.

9. The fact that the ACTUAL temperature is indicated on the display (digital value and progress bar) means the heating and control process can be observed:

The unit is functioning correctly if the temperature indicated on the display has a harmonious motion, in other words it must not jump abruptly, fluctuate, or deviate temporarily in the wrong direction. This kind of behavior would indicate that the U_R measurement cable has been laid incorrectly.

If an error message is displayed, please proceed as described in section 9.18 "Error messages" on page 37.

10. Burn in the heatsealing band (↪ section 8.3 "Heatsealing band" on page 20) and repeat the AUTOCAL function.

The RESM is now ready

Always use a heatsealing band with the correct alloy, dimensions, and copper plating in order to avoid malfunctions and overheating.

To prevent dangerous situations, refer to the risk analysis for the machine or plant.

Continue with section 8.4.1, steps 8 and 9.

9.2 Display

RESM-5. This message also includes details of the software version.

9.2.1 Power-up message

A power-up message appears on the display for approximately 2 seconds when you switch on the

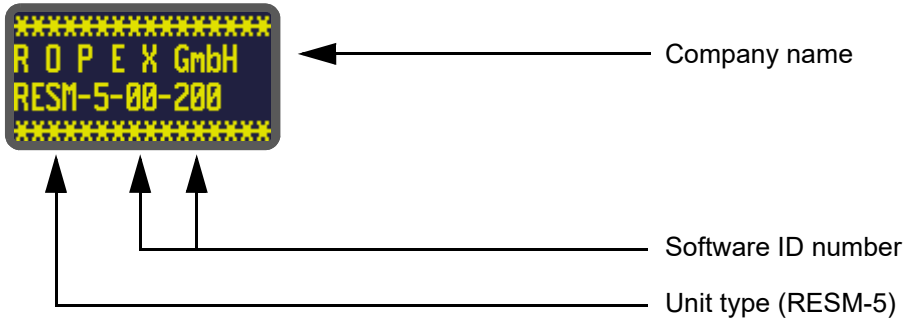

9.2.2 Display in home position

If no settings are being specified on the RESISTRON monitoring device and no error messages are visible, the display is in the home position; the maximum tem-

perature is shown as a digital value and the ACTUAL temperature as a digital value and a progress bar. The main controller's measuring impulses are represented as flashing asterisks.

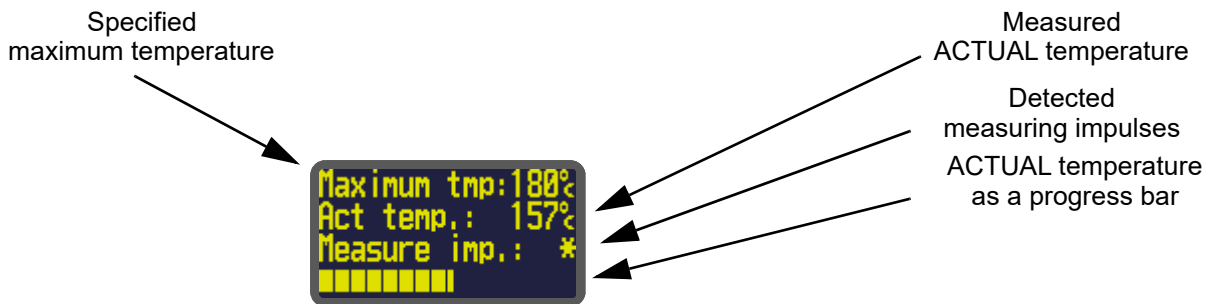

9.2.3 Settings / Configuration menus

You specify the various parameters on two menu levels: the Settings (control) menu and the Configuration menu (↘ section 9.4 "Menu structure" on page 26)

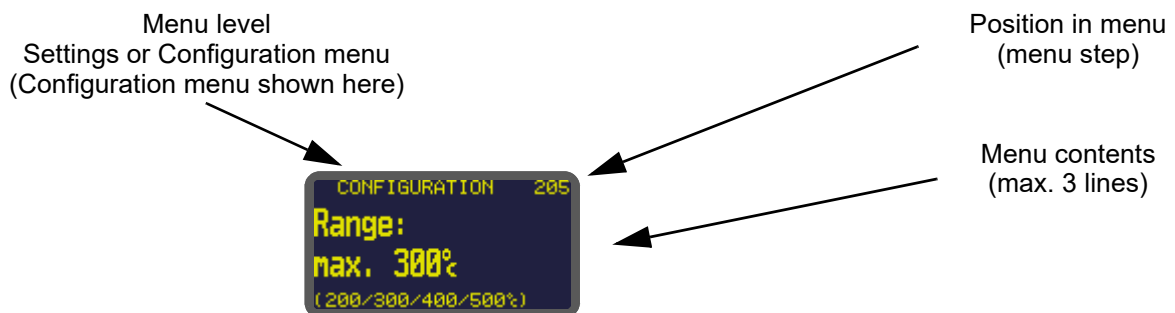

9.2.4 Error message

The RESM-5's error diagnostics function is always active. If an error is detected, it is immediately indicated

on the display in the form of an error message (see section 9.17 "System monitoring / alarm output" on page 36).

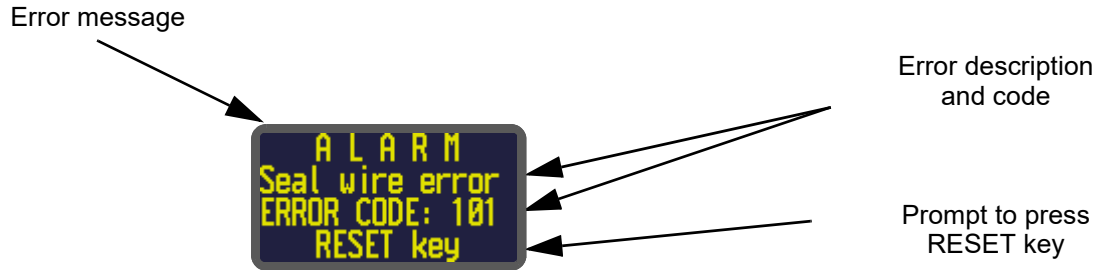

9.3 Navigation in the menus

9.3.1 Navigation when no alarm is indicated

A "MENU" key is provided for navigating through the various menu steps and levels. By pressing this key briefly (<1s) at any time, you select the next menu step. You select the previous step by pressing the "MENU" key for between 1 and 2s. By pressing the key for longer (>2s), you can return to the home position from

anywhere in the menu system, provided no alarms are indicated on the RESISTRON monitoring device. In this case, you see the Alarm menu.

If the display is in the home position or an alarm is indicated and you press the "MENU" key for longer than 2s, the Configuration level is selected directly (step 201 appears first).

In addition to this, you always return to the home position if no keys are pressed for a period of 30s. Exception: There is no automatic return after 30s from "AUTOCAL" or "Alarm".

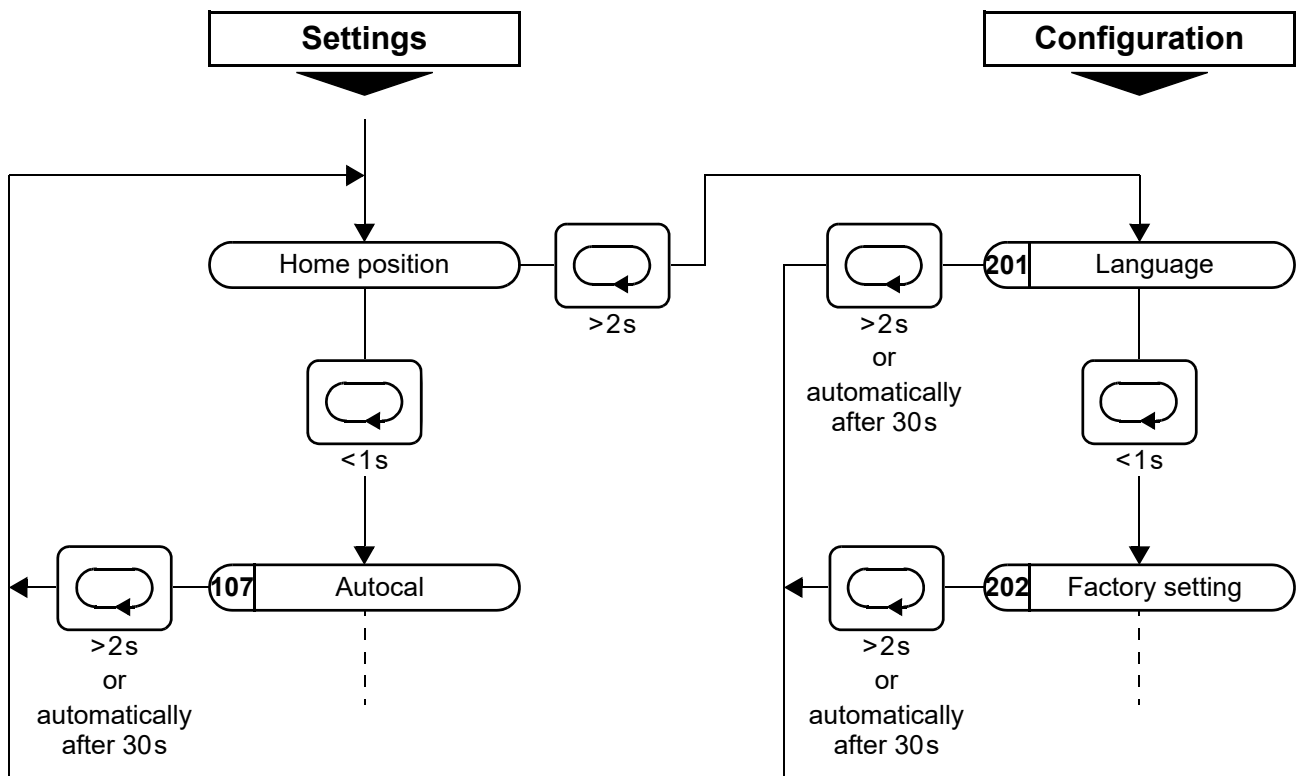

9.3.2 Navigation when an alarm is indicated

If an alarm is indicated, the RESM-5 shows the Alarm menu. Some errors can be acknowledged by pressing the "RESET" key (↵ section 9.17 "System monitoring / alarm output" on page 36). In this case, the RESM-5 returns to the home position.

If the error can be rectified by running the AUTOCAL function, you can select the "AUTOCAL" step directly by briefly pressing the "MENU" key (<2s). You can then

run the "AUTOCAL" function by pressing "ENTER" (↵ section 9.8 "Automatic zero calibration (AUTOCAL)" on page 32).

If you press the "MENU" key for longer than 2s in the Alarm menu, the Configuration level is selected directly (step 201 appears first). You can return from the Configuration menu to the Alarm menu either by pressing the "MENU" key for longer than 2s or by not pressing any keys for 30s.

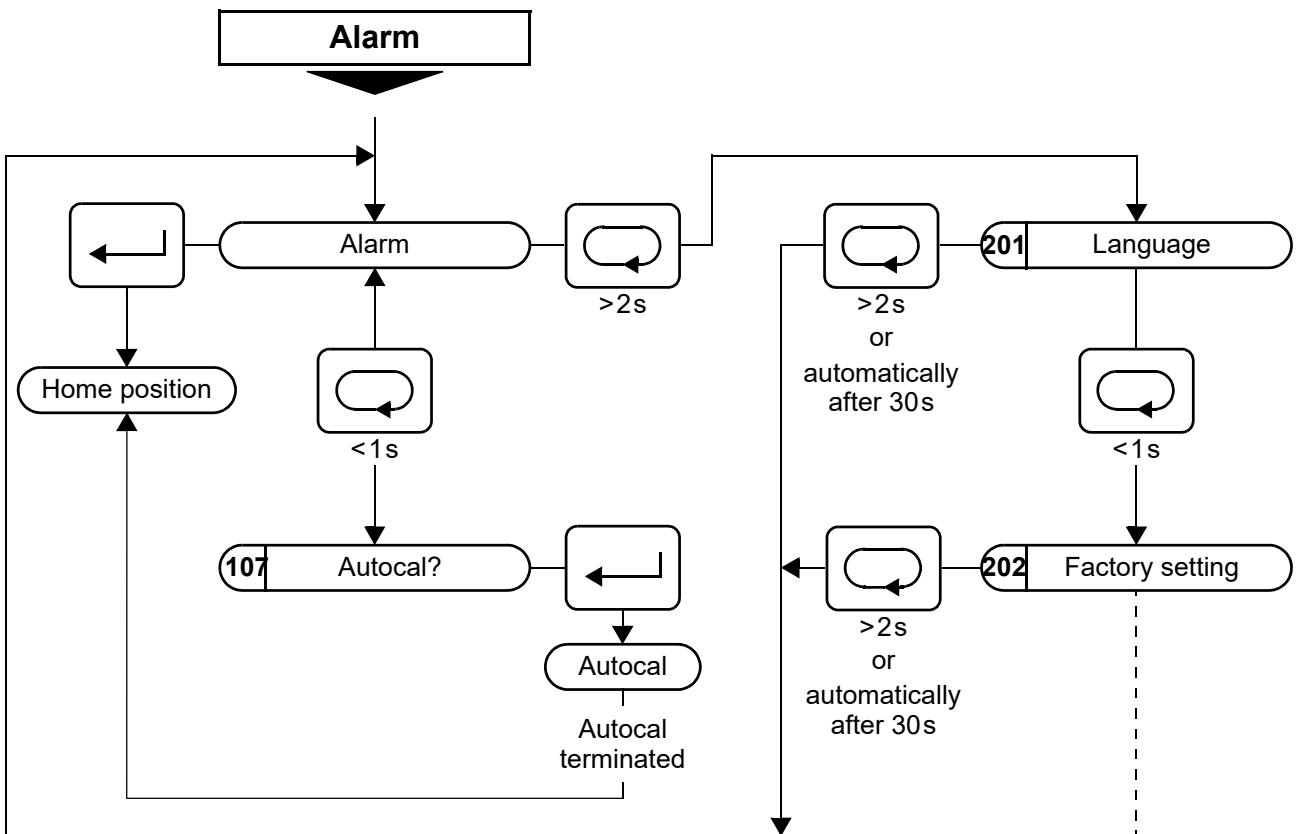

9.4 Menu structure

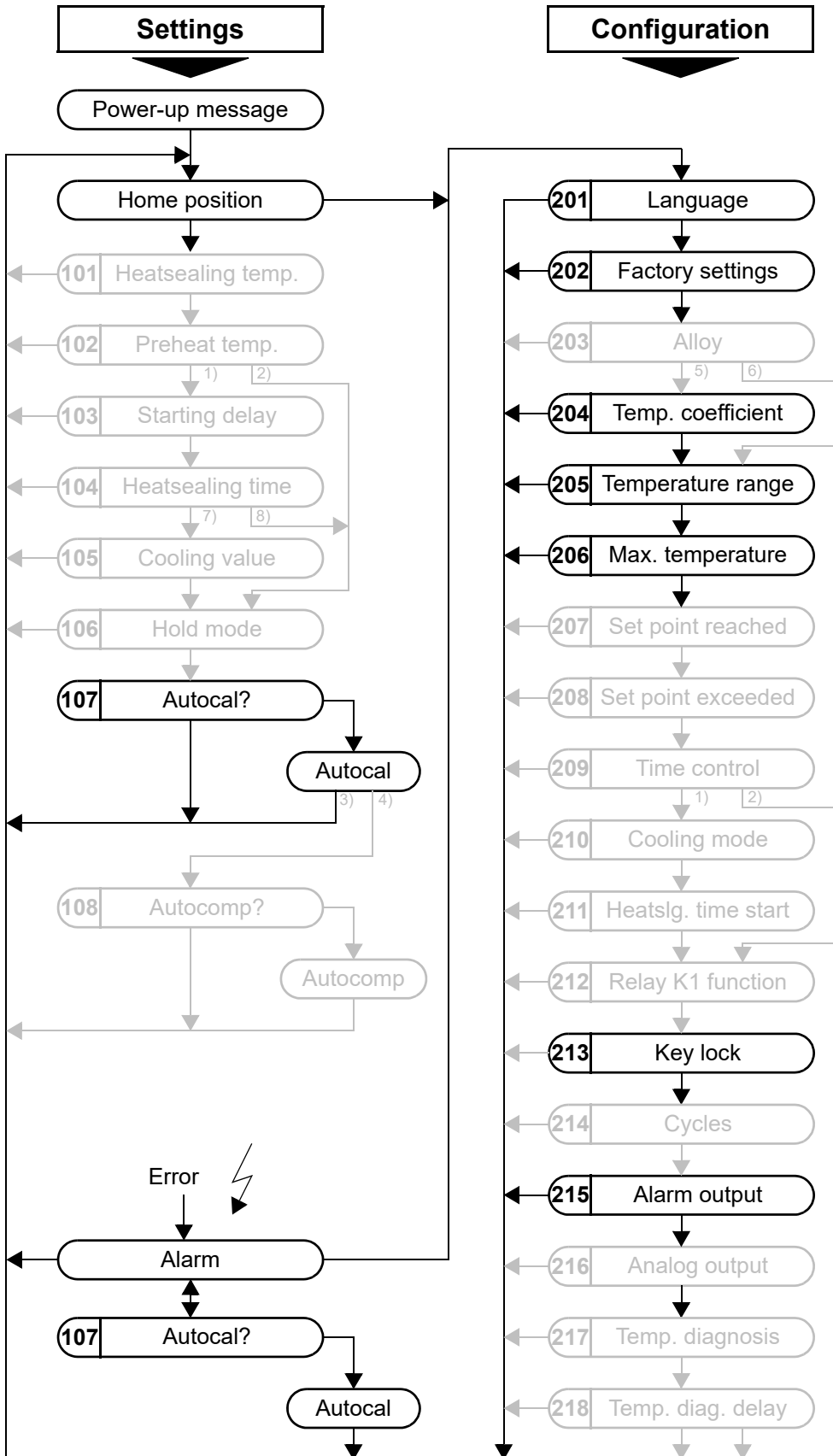

Continued on next page

Configuration

Continued from previous page

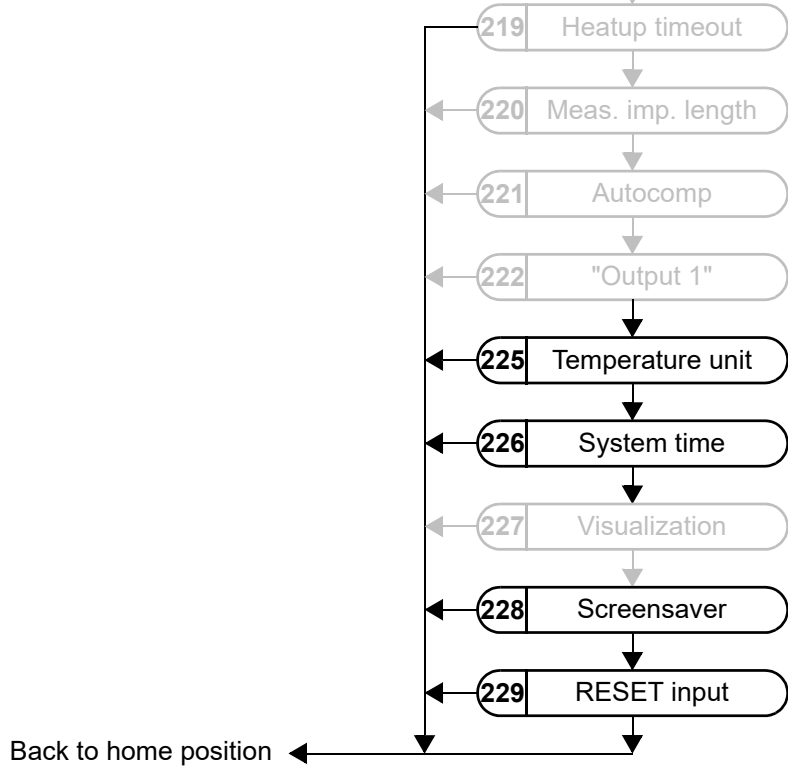

9.5 Menu steps

No.	Name	Description	Setting range
	Home position	<p>The specified maximum temperature and the current actual value are displayed as digital data. The actual value is also represented as a progress bar.</p> <p>Measuring impulses generated by the main controller to be monitored are shown as asterisks next to the words "Measuring impulse".</p> <p>By pressing the "ENTER" key, you can display information about the unit (unit name, firmware version, serial number, article number).</p>	
107	Autocal	<p>The "AUTOCAL" function adjusts the RESM-5 to the current and voltage signals that are present in the system.</p> <p>The required calibration temperature can be set with the "UP" and "DOWN" keys. Pressing the "ENTER" key stores the set value and starts the "AUTOCAL" function.</p> <p>The message "- Calibration -" appears on the display while the AUTOCAL function is executing and a counter counts down from 15 to 0. When the unit has been calibrated successfully, the display returns directly to the home position.</p> <p>If the unit cannot be calibrated, the AUTOCAL function is canceled and an error message is displayed instead.</p>	0...40°C
201	Language	This menu step selects the desired display language.	English, German
202	Factory settings	<p>The RESM-5 can be reset to the factory settings by pressing the "ENTER" key (↵ section 10 "Factory settings" on page 43).</p> <p>You can use the "UP" and "DOWN" keys to determine whether</p> <ul style="list-style-type: none"> • The RESM-5 should be reset to the ROPEX factory settings • The current configuration should be specified as the default setting • The RESM-5 should be reset to a previously specified default setting 	
204	Temp. coefficient	This menu step allows you to specify the temperature coefficient of the heatsealing band material in 10ppm/K increments using the "UP and "DOWN" keys.	400...4000ppm/K

No.	Name	Description	Setting range
205	Temperature range	Various temperature ranges can be selected here. The temperature range setting permits the RESM-5 to be adjusted to the required operating range. It also determines the scale that is used for the progress bar and the analog output.	200°C 300°C 400°C 500°C
206	Max. temperature	This menu step allows you to specify the maximum permitted temperature measurement in the range defined with step 205. An error message is output if this maximum temperature is exceeded.	0 to max. temperature range (step 205)
213	Key lock	You can specify whether or not the "AUTOCAL" function can be started with step 107 by pressing the "ENTER" key. <ul style="list-style-type: none"> No key: The "AUTOCAL" function can be started by pressing the "ENTER" key. AUTOCAL key: The "AUTOCAL" function cannot be started by pressing the "ENTER" key. 	No key AUTOCAL key
215	Alarm output	This menu step configures the switching behavior of the alarm output. <ul style="list-style-type: none"> normal: The alarm output (terminal 18) is energized at alarm. inverse: The alarm output (terminal 18) is de-energized at alarm. normal w. RESET: The alarm output (terminal 18) is energized at alarm or when the ALARM-IN/RESET input is energized. inverse w. RESET: The alarm output (terminal 18) is de-energized at alarm or when the ALARM-IN/RESET input is energized. 30sec. inactive: The alarm output (terminal 18) is de-energized for a period of 30 seconds. This setting is not saved. 1 min. inactive: The alarm output (terminal 18) is de-energized for a period of 1 minute. This setting is not saved. 5 min. inactive: The alarm output (terminal 18) is de-energized for a period of 5 minutes. This setting is not saved. 	normal inverse normal w. RESET inverse w. RESET 30sec. inactive 1 min. inactive 5 min. inactive
225	Temperature unit	Unit for temperature indication and value selection	Celsius Fahrenheit
226	System time	The current date and time are displayed by the system clock in real time. Select the individual values (hours, minutes, seconds, day, month, and year) by pressing the ENTER key (the values flash), then press this key again to store them. The values can be edited using the "UP" and "DOWN" keys.	

No.	Name	Description	Setting range
228	Screensaver	To extend the life of the OLED display, you can specify the time here after which it is dimmed. If you set "0min", the display is not dimmed. The display lights up again as soon as a key is pressed, an alarm occurs, or an input signal is activated.	0 (=off)...20min
229	ALARM-IN/RESET input	<p>This menu step configures the behavior of the ALARM-IN/RESET input.</p> <ul style="list-style-type: none"> • normal: An active alarm is reset if the ALARM-IN/RESET input (terminal 7) is energized. • normal w. STANDBY survey: An active alarm is reset if the ALARM-IN/RESET input (terminal 7) is energized. The RESM-5 generates error message 120 "STANDBY not observed" if the main controller controls the heatsealing band (measuring impulses or control mode) while the ALARM-IN/RESET input is energized. • inverse: An active alarm is reset if the ALARM-IN/RESET input (terminal 7) is de-energized. • inverse w. STANDBY survey: An active alarm is reset if the ALARM-IN/RESET input (terminal 7) is de-energized. The RESM-5 generates error message 120 "STANDBY not observed" if the main controller controls the heatsealing band (measuring impulses or control mode) while the ALARM-IN/RESET input is de-energized. 	normal normal w. STANDBY survey inverse inverse w. STANDBY survey

9.6 Monitoring temperature setting (maximum temperature set point)

You can set the maximum temperature on the RESISTRON monitoring device RESM-5 with menu step 206.

! The maximum value of the setting range is limited by the temperature range specified with step 205 in the Configuration menu.

The set point selected for the heatsealing temperature must be at least 40°C. The set maximum temperature is displayed in the main menu after it has been entered.

! To prevent dangerous situations, refer to the risk analysis for the machine or plant.

9.7 Temperature indication / actual value output

If the display is in the home position, the ACTUAL temperature is indicated there both as a digital value and as a progress bar.

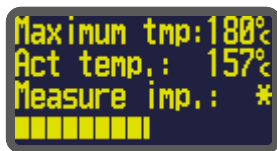

The heating and control process can thus be observed at any time. The RESISTRON monitoring device RESM-5 additionally supplies an electrically isolated, analog 0...10VDC

signal, which is proportional to the real ACTUAL temperature, at terminals 17+14.

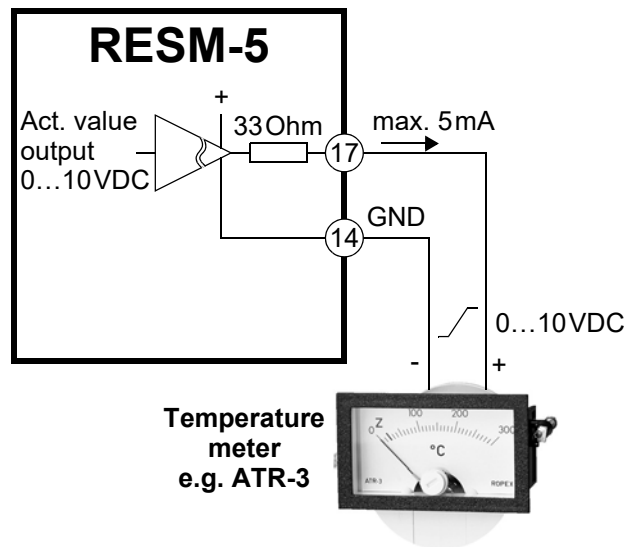

Voltage values:

0VDC → 0°C

10VDC → 300°C or 500°C

(depending on the unit configuration)

The relationship between the change in the output voltage and the ACTUAL temperature is linear.

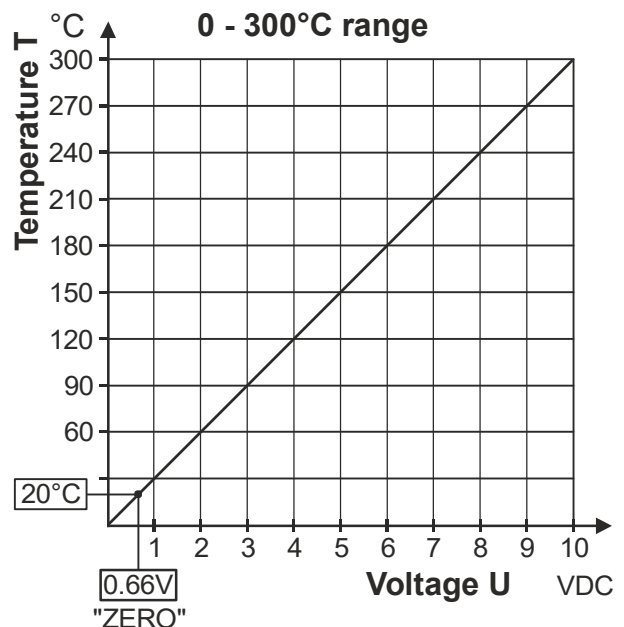

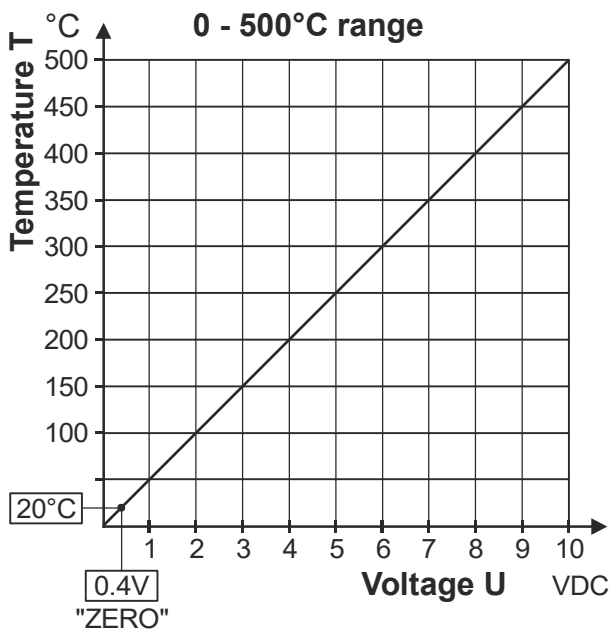

Only the 300°C and 500°C temperature ranges appear at this actual value output. If a temperature range of 200°C is set with step 205 in the Configuration menu, it appears at this output in the 0...300°C range. The 400°C temperature range is indicated as 0...500°C. An indicating instrument can be connected to this output in order to visualize the temperature of the heatsealing band.

The characteristics of the ROPEX ATR-x temperature meter (size, scaling, dynamic response) are ideally suited to this application (↪ section 4 "Accessories and modifications" on page 11).

The meter not only facilitates SET-ACTUAL comparisons but also enables other criteria such as the heating rate, set point reached within the specified time, cooling of the heatsealing band etc. to be evaluated.

The temperature meter additionally permits disturbances in the control loop (loose connections, contacting or wiring problems) as well as any line disturbances to be observed extremely effectively and interpreted accordingly. The same applies if several neighboring control loops interfere with one another. If an alarm is indicated, this analog output is used to show a selective error message in addition to the value on the display (↪ section 9.18 "Error messages" on page 37).

9.8 Automatic zero calibration (AUTOCAL)

Owing to the automatic zero calibration (AUTOCAL) function, there is no need to adjust the zero point

manually on the RESISTRON monitoring device. This function adjusts the RESM-5 to the current and voltage signals that are present in the system. This function can be activated in two ways:

- By means of a 24 VDC signal at terminals 5+14.

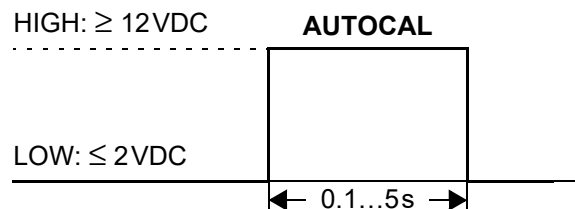
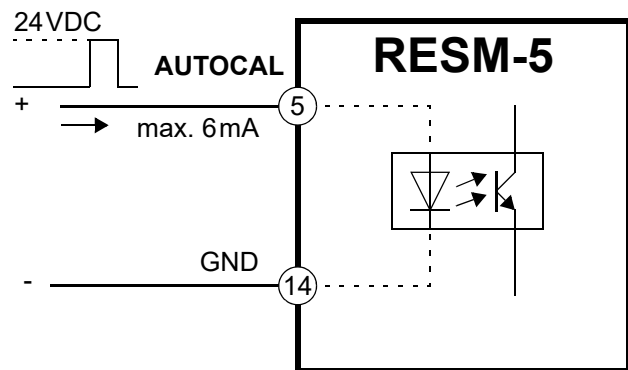

- By selecting step 107 in the Settings menu and pressing the "ENTER" key

You can activate this function by selecting step 107 in the Settings menu and then pressing the "ENTER" key. The current base temperature (ambient temperature) of the sealing bar(s) that is required for calibration can be preset in the 0...40°C range using the "UP" and "DOWN" keys.

The zero point is calibrated to 20°C at the factory. The automatic calibration takes around 10...15 seconds. The heatsealing band is not heated during this process.

The message "- Calibration - Please wait..." appears on the display while the "AUTOCAL" function is executing and a counter counts down from 15 to 0. The actual value output (terminals 17+14) changes to 0...3°C (i.e. 0 VDC) as long as it is counting.



If the temperature of the heatsealing band varies, the "AUTOCAL" function is executed a maximum of three times. If the function still cannot be terminated

successfully, an error message appears (↳ section 9.18 "Error messages" on page 37).

⚠ You should always wait for the heatsealing band and the bar to cool down (to ambient temperature) before activating the "AUTOCAL" function.

Reasons for disabled AUTOCAL function:

1. The "AUTOCAL" function cannot be activated if the heatsealing band cools down at a rate of more than 0.1K/s. This is additionally indicated in the Settings menu (step 107) by the message "Heatsealing band still hot! Please wait...". This message is also displayed if the unit cannot be calibrated when the external "AUTOCAL" signal is active (cooling rate too fast).
2. If the "START" signal on the temperature controller is activated, the "AUTOCAL" function is not executed. This is additionally indicated in the Settings menu (step 107) by the message "Autocal disabled! (START signal active)".
3. If the "ALARM-IN/RESET" signal (24VDC) is activated, the "AUTOCAL" function is not executed.
4. The AUTOCAL function cannot be activated if error codes 101...103, 109 (up to software revision 202), 201...203, 801, or 9xx occur when the RESM-5 is started up (↳ section 9.18 "Error messages" on page 37). It cannot be activated with error codes 201...203, 801, or 9xx if the RESM-5 has operated correctly at least once since startup.

9.9 "ALARM-IN/RESET" signal

The RESISTRON monitoring device RESM-5 can be reset by means of an external "ALARM-IN/RESET" signal (terminals 7+14). As a result of this:

- A message appears on the display (if no alarm is indicated by the RESM-5)
- The standby monitoring function for the main controller to be monitored is activated (provided this function has been activated with step 229 in the Configuration menu)

- An error message is reset if one is present (Note: The error message is not reset until the "ALARM-IN/RESET" signal is deactivated)

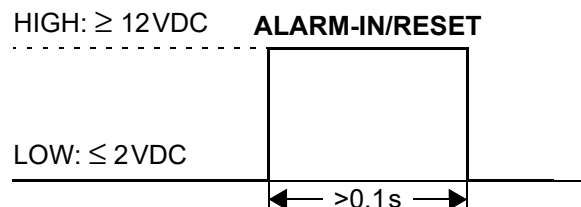
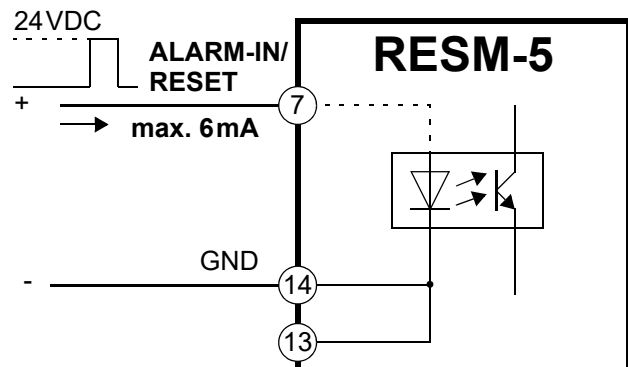

The actual value output changes to 0...3°C (i.e. approximately 0VDC) while the "ALARM-IN/RESET" signal is being activated.

The message "ALARM IN / RESET active" is additionally displayed on the RESM-5 when the "ALARM-IN/RESET" signal is active.

The "AUTOCAL" function is not canceled if the "ALARM-IN/RESET" signal is activated while it is still executing.

⚠ Note the configuration of the alarm output in the Configuration menu (step 215) if you use the ALARM-IN/RESET signal (↳ section 8.2.7 "Configuration of the alarm output" on page 19).

⚠ The RESM-5 performs an internal initialization lasting approximately 500ms after the "ALARM-IN/RESET" signal is deactivated. The unit is not ready to operate again until it has finished.

9.10 AUTOCAL function disabled

The "AUTOCAL" function can be configured with step 213 in the Configuration menu when step 107 is displayed.

This prevents the heatsealing bands from being inadvertently calibrated if the "ENTER" key is pressed. Disabling this function has no effect on the calibration

option via the external AUTOCAL input (terminals 5+14).

The following settings are possible:

1. Disable **"No key" (factory setting)**
Pressing the "ENTER" key starts the "AUTOCAL" function when step 107 is displayed.
2. Disable **"AUTOCAL key"**
The "ENTER" key is locked when step 107 is displayed, in other words it has no function.

9.11 Temperature unit Celsius / Fahrenheit

The unit for the temperature indication and value selection can be switched between °C (Celsius) and °F (Fahrenheit). You set it with step 225:

1. **"Celsius" (factory setting)**
Temperature indication and value selection in degrees Celsius (°C).
2. **"Fahrenheit"**
Temperature indication and value selection in degrees Fahrenheit (°F).

 **You can change the temperature unit while the RESISTRON monitoring device is operating.**

 **Even if you specify temperature indication and value selection in degrees Fahrenheit (°F), the RESM-5 always uses Celsius (°C) internally. This function could therefore lead to discrepancies between the values owing to the conversion from Celsius → Fahrenheit.**

9.12 Disable Configuration menu

You can disable all changes to values or parameters in the Configuration menu. This prevents the unit configuration from being tampered with by unauthorized persons. In the factory setting the Configuration menu is not disabled.

 **You can still display all steps, values, and parameters even if the Configuration menu is disabled. However, you are no longer allowed to enter or change any values.**

 **The language selected with step 201 can still be changed even if the Configuration menu is disabled (↪ section 8.2.2 "Menu language" on page 19).**

For disabling the configuration menu there are two possibilities:

Pressing the „MENU“ key (during power-up of the monitoring device)

The Configuration menu can be enabled or disabled by pressing the "MENU" key for 2seconds while the power-up message is displayed (after switching on the unit, ↪ section 9.2.1 "Power-up message" on page 23). A message confirming the disable then appears for 3seconds before the display returns to the home position.



The same message is also displayed for 5seconds when you open the Configuration menu to indicate that this menu is disabled.

The menu remains disabled until the disable is canceled again. To do this, simply repeat the above procedure (press the "MENU" key for 2seconds while the power-up message is displayed). You then see a message confirming that the disable has been canceled.



Rotary coding switch (as of August 2014)

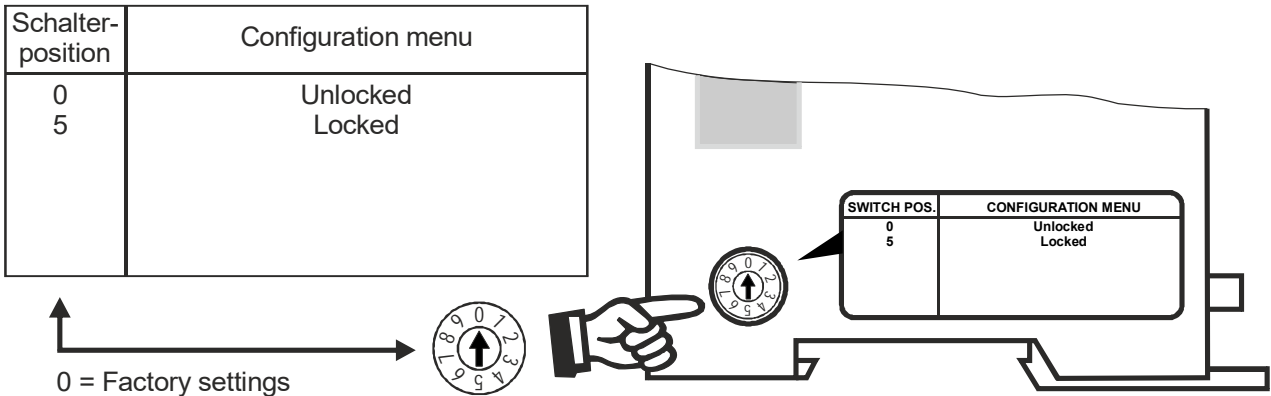

The Configuration menu is not disabled as default ("0" position). If you set the rotary coding switch to "5", the Configuration menu is disabled and you cannot make any changes there.

! If you change the setting of the rotary coding switch, the new setting takes effect immediately. You do not need to switch the unit off and then on again.

The following message is displayed for 5 seconds when you open the Configuration menu to indicate that this menu is disabled.



9.13 Display brightness

You can set the brightness of the OLED display in four steps (25%, 50%, 75%, 100%) with the "UP" and "DOWN" keys when the display is in the home position. The factory setting is 75%.

The life of the OLED display can be extended by reducing the brightness.

The "Screensaver" parameter in step 228 allows you to automatically dim the display after a defined time (in minutes). If no keys are pressed during this time, the display is dimmed to 25% brightness. If you set "0min", the display is not dimmed.

As soon as you press a key again or an alarm is detected, the display returns to the programmed brightness level.

9.14 Undervoltage detection

Trouble-free operation of the RESISTRON monitoring device is guaranteed within the line voltage and 24 VDC supply voltage tolerances specified in section 5 "Technical data" on page 12.

If the line voltage drops below the permitted lower limit, the RESISTRON monitoring device is switched to standby mode. No more measurements take place and the temperature is no longer monitored. The display changes to indicate this.



The main menu is displayed and normal operation resumed when the input voltage returns to the specified tolerance range again.

The alarm output is not energized at undervoltage. Standby mode is indicated by 0...3 °C (i.e. approx. 0V) at the analog output.

! Trouble-free operation of the unit is only guaranteed within the specified tolerance range of the input voltage. An external voltage monitor must be connected to prevent malfunctions due to low line voltage.

9.15 Unit information

You can display information about the unit by pressing the "ENTER" key when the display is in the home position. The unit name appears together with the firmware version, article number, and serial number. The display

returns to the home position if you press the "ENTER" key again or at the latest after 30s.

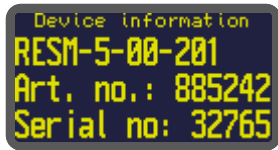

9.16 Diagnostic interface / visualization software

An interface with a 6-pole Western socket is provided for system diagnostics and process visualization. This interface allows a data connection to be set up to the ROPEX visualization software using the ROPEX CI-USB-1 communication interface.

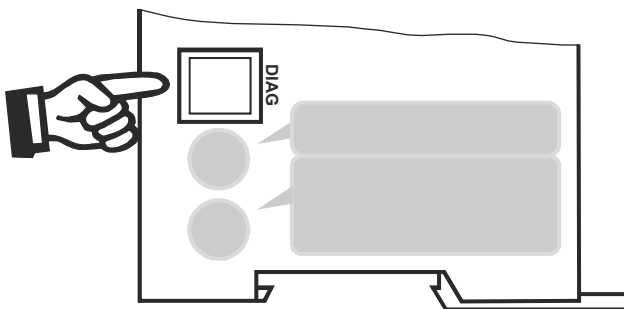

⚠ Only a ROPEX communication interface is allowed to be connected to the diagnostic interface. Connecting another device (e.g. a

telephone cable) could damage the unit and result in malfunctions.

The ROPEX visualization software is described in a separate document.

9.17 System monitoring / alarm output

To increase operational safety and avoid faulty heatsealing, the RESISTRON monitoring device incorporates special hardware and software features that facilitate selective error detection and diagnosis. Both the external wiring and the internal system are monitored.

These features assist the operator in identifying the cause of abnormal conditions.

A system fault is reported or differentiated by means of the following indications.

A.) Error code on the display:



The cause of a fault can be localized quickly and easily with the help of the error code that appears on the display. Please refer to section 9.18 "Error messages" on page 37 for a list of the possible error codes.

B.) Alarm output (terminals 18+12):

This output is set in the factory as follows:

- **LOW (OPEN)** if error code 104...106, 111...113, or 211 is displayed. However, the contact closes if a "START" signal on the temperature controller is present in one of these states.
- **HIGH (CLOSED)** if error code 101...103, 107, 108, 109, 201...203, 801, or 9xx appears.

If the alarm output has the opposite configuration to the factory setting (↪ section 8.2.7 "Configuration of the alarm output" on page 19), these states are reversed.

C.) Error code indicated via the actual value output 0...10VDC (terminals 20+24):

Since a temperature indication is no longer necessary if a fault occurs, the actual value output is used to display error messages in the event of a fault.

Thirteen voltage levels are available for this purpose in the 0...10VDC range, each of which is assigned an error code (↪ section 9.18 "Error messages" on page 37).

If a state that requires AUTOCAL occurs – or if the unit configuration is not correct – (error codes 104...106, 111...113, 211), the signal at the actual value output jumps back and forth at 1 Hz between the voltage value corresponding to this error and the end of the scale (10VDC, i.e. 300°C or 500°C). If the "START" signal on the temperature controller is set in one of these states, the voltage value does not change any more.

 **An error message can only be reset by pressing the "RESET" key, activating the**

"ALARM-IN/RESET" signal at terminals 7+14 (↪ section 9.9 ""ALARM-IN/RESET" signal" on page 33), or switching the RESM-5 off and then on again.

 **Invalid error messages may appear when the RESM-5 is switched off owing to the undefined operating state. This must be taken into account when they are evaluated by the higher-level controller (e.g. a PLC) in order to avoid false alarms.**

9.18 Error messages

The table below shows how the analog voltage values that appear at the actual value output correspond to the errors that have occurred. It includes a description of each error and the required corrective action. The block diagram in section 9.19 "Fault areas and causes (main RESISTRON controller)" on page 41 enables a particular error to be cleared quickly and efficiently.

The error codes described below can also be displayed using the ROPEX visualization software (↪ section 9.16 "Diagnostic interface / visualization software" on page 36) to facilitate troubleshooting.

 **If the actual value output is evaluated in order to identify an error message – in the higher-level controller, for instance – the tolerance window must be adjusted to prevent it from being incorrectly interpreted. Please note the tolerances of the actual value output (↪ section 5 "Technical data" on page 12).**

Part 1 of 3: Error messages (faults)

NOTE: The error messages shown here are output as faults (a constant error voltage appears at the actual value output; the alarm output is energized).

Error code		Act. val. output voltage [V]	Cause	Action if machine started for first time	Action if machine already operating, HS band not changed
1	101	0.66	No current signal	Fault area ①	Fault area ①
2	102	1.33	No voltage signal	Fault area ③	Fault area ③
	118		Voltage signal has wrong polarity (↩ section 7.3 "Wiring diagram" on page 17)	Reconnect/ Interchange U_R measuring wire to terminals 8+9	Reconnect/ Interchange U_R measuring wire to terminals 8+9
3	103	2.00	No current / voltage signals	Fault area ②	Fault areas ②⑨
	120		STANDBY test failed		
4	107	2.66	Temperature step, down	Fault areas ④⑤⑥ (loose contact)	Fault areas ④⑤⑥ (loose contact)
	108		Temperature step, up		
	109		Maximum temperature exceeded	Check application	Check application
	307		Temperature too low / high		
	308				
309					
310					
5	201	3.33	Line frequency missing / fluctuates	Check power supply	Check power supply
	202		Line frequency too high / fluctuates		
	203		Line frequency too low / fluctuates		
6	304	4.00	Heatup time too long	Run RESET	Run RESET

Part 1 of 3: Error messages (faults)

NOTE: The error messages shown here are output as faults (a constant error voltage appears at the actual value output; the alarm output is energized).

Error code		Act. val. output voltage [V]	Cause	Action if machine started for first time	Action if machine already operating, HS band not changed
7	901	4.66	No line voltage / sync signal	Replace unit	Replace unit
	913		Triac defective	Replace unit	Replace unit
	914		Internal fault, unit defective	Replace unit	Replace unit
	915				
	916		Internal fault	Replace unit	Replace unit
	919				
	920		Internal fault	Replace unit	Replace unit
936	Main controller indicates alarm				

Part 2 of 3: Error messages (warnings)

NOTE: The specified error messages are initially output as warnings (actual value output jumps back and forth between two values; alarm output is de-energized). When the "START" signal on the temperature controller is activated, the warning changes to a fault (actual value output no longer jumps back and forth, see ***bold italic values***; alarm output is energized).

Error code	Act. val. output voltage [V]	Cause	Action if machine started for first time	Action if machine already operating, HS band not changed	
8	↔ 5.33 ↔ ↔ 10 ↔	Current signal incorrect, incorrect specification of impulse transformer	Run AUTOCAL, check specification of transformer, fault areas ⑦ ⑧	Fault areas ④ ⑤ ⑥ (loose contact)	
		Voltage signal incorrect, incorrect specification of impulse transformer			
		Voltage and current signals incorrect, incorrect specification of impulse transformer			
		119	Measurement pause too short during AUTOCAL		Run AUTOCAL, don't start controller
		302	Temperature too low, calibration wasn't performed, loose contact, ambient temp. fluctuates		Run AUTOCAL and / or fault areas ④ ⑤ ⑥ (loose contact)
		303	Temperature too high, calibration wasn't performed, loose contact, ambient temp. fluctuates		
9	↔ 6.00 ↔ ↔ 10 ↔	Data error	Run AUTOCAL	Run AUTOCAL	

Part 3 of 3: Error messages (warnings)

NOTE: The specified error messages are initially output as warnings (actual value output jumps back and forth between two values; alarm output is de-energized). When the "START" signal on the temperature controller is activated, the warning changes to a fault (actual value output no longer jumps back and forth, see **bold italic values**; alarm output is energized).

Error code	Act. val. output voltage [V]	Cause	Action if machine started for first time	Action if machine already operating, HS band not changed
10 111	↔ 6.66 ↔ ↔ 10 ↔	Current signal incorrect, calibration not possible	Fault area ⑧, check configuration	Fault areas ④ ⑤ ⑥ (loose contact)
11 112	↔ 7.33 ↔ ↔ 10 ↔	Voltage signal incorrect, calibration not possible	Fault area ⑦, check configuration	Fault areas ④ ⑤ ⑥ (loose contact)
12 113	↔ 8.00 ↔ ↔ 10 ↔	Current / voltage signals incorrect, calibration not possible	Fault areas ⑦ ⑧, check configuration	Fault areas ④ ⑤ ⑥ (loose contact)
13 114	↔ 8.66 ↔ ↔ 10 ↔	Temperature fluctuates, calibration not possible	Run AUTOCAL and / or fault areas ④ ⑤ ⑥ (loose contact)	Run AUTOCAL and / or fault areas ④ ⑤ ⑥ (loose contact)

9.19 Fault areas and causes (main RESISTRON controller)

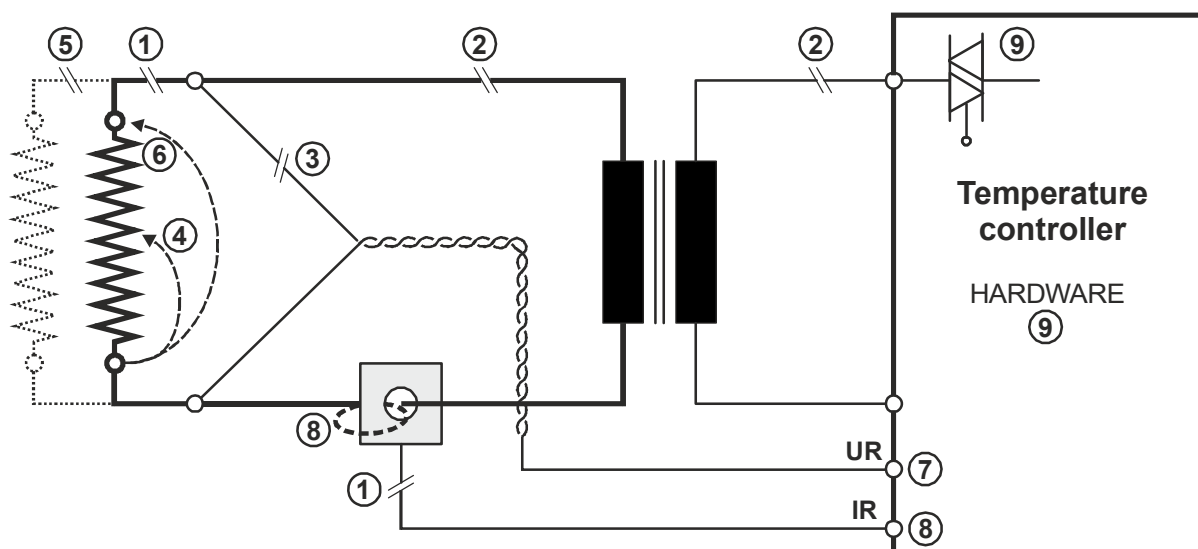

The table below explains the possible error causes.

Fault area	Explanation	Possible causes
①	Load circuit interrupted after U_R pickoff point	- Wire break, heatsealing band break - Contact to heatsealing band is defective
	PEX-W2 / W3 current transformer signal interrupted	- I_R measurement cable from current transformer interrupted
②	Primary circuit interrupted	- Wire break, triac in controller defective - Primary winding of impulse transformer interrupted - Relay Kb opened
	Secondary circuit interrupted before U_R pickoff point	- Wire break - Secondary winding of impulse transformer interrupted
③	No U_R signal	- Measurement cable interrupted
④	Partial short-circuit (ΔR)	- Heatsealing band partially bypassed by conducting part (clamp, opposite heatsealing bar etc.)
⑤	Parallel circuit interrupted	- Wire break, heatsealing band break - Contact to heatsealing band is defective
⑥	Total short-circuit	- Heatsealing band installed incorrectly, no insulation at heatsealing bar ends or insulation incorrectly installed - Heatsealing band completely bypassed by conducting part
⑦	U_R signal incorrect	- U_2 outside of permissible range from 0.4...120VAC
⑧	I_R signal incorrect	- I_2 outside of permissible range from 30...500A
	Wire incorrectly laid through PEX-W2 / W3 current transformer	- Check number of times wire is laid through (minimum of twice required for currents < 30A)
⑨	Internal unit fault	- Hardware fault (replace unit)

10 Factory settings

The RESISTRON monitoring device RESM-5 is configured at the factory as follows:

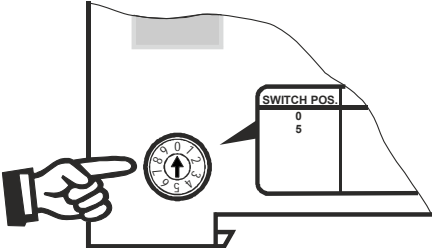
<u>Settings menu</u>	Step 107 AUTOCAL temperature: 20°C
<u>Configuration menu</u>	<p>Step 201 Language: German This selection is NOT changed if the factory settings are restored with step 202 in the Configuration menu.</p> <p>Step 204 Temp. coefficient: TCR=400ppm/K Step 205 Temperature range: 300°C Step 206 Max. temperature: 40°C Step 213 Key lock: No key Step 215 Alarm output: Normal (energized at alarm) Step 225 Temperature unit: Celsius Step 228 Screensaver 5 min Step 229 ALARM-IN/RESET input: Normal</p>
<u>Rotary coding switch for locking the Configuration menu (as of August 2014)</u>	<div style="display: flex; align-items: center;">  <div style="margin-left: 20px;"> <p>Configuration menu: Unlocked</p> <p>Rotary coding switch: „0“ position</p> </div> </div>

10.1 Customer settings

The unit's factory settings can be defined or restored with step 202 in the Configuration menu. You can store customer settings in addition to the Ropex settings:



The following settings are possible:

1. "Restore Ropex settings" (factory setting)

By choosing this option, you restore the values listed in section 10 "Factory settings" on page 43. These values correspond to the factory settings with which the unit was shipped.

2. "Define customer settings"

By choosing this option, you save the values that are currently defined in the unit's Settings and Configuration menus as "customer settings". These "customer settings" are independent of the Ropex settings. Machine-specific settings can be stored in the unit in this way.

3. "Restore customer settings"

By choosing this option, you restore the "customer settings" that were defined as described in 2.

When the unit is shipped, the "customer settings" are identical to the Ropex settings.

After pressing the "ENTER" key in this menu, you are asked to confirm the new settings (safety query).

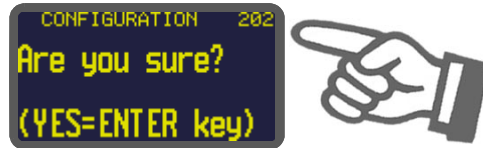

If you confirm these settings by pressing the "ENTER" key for approximately 2 seconds, you then see another message.



You can also cancel the new settings by pressing the "MENU", cursor "UP", or cursor "DOWN" keys. Step 203 then appears on the display.









The language selected with step 201 in the Configuration menu remains set if the previous settings are restored.

11 Maintenance

The unit requires no special maintenance. Regular inspection and / or tightening of the terminals is recommended. Dust deposits on the unit can be removed with dry compressed air.

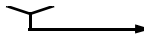
To prevent dangerous situations, refer to the risk analysis for the machine or plant (e.g. carry out regular functional tests).

12 How to order

	<p>RESM - 5/ . . . V AC</p> <p>  115: Power supply 115VAC, Art. No. 885241 230: Power supply 230VAC, Art. No. 885242 400: Power supply 400VAC, Art. No. 885243 </p> <p>Scope of supply: Unit includes connector plug-in parts (current transformer must be ordered separately)</p> <p>Modification MOD . . (optional, if required)</p> <p>  e.g. 01: MOD 01, Art. No. 800001 (booster for low voltage) </p> <p>Please indicate the article numbers of the unit and the required modifications (optional) in all orders, e.g. RESM-5/400VAC + MOD 01 (unit for 400VAC power supply with booster for low voltage) Art. Nos. 885243 + 800001 must be ordered</p>
	<p>Current transformer PEX-W3 Art. No. 885105</p>
	<p>Line filter LF- . . 480</p> <p>  06: Continuous current 6A, 480VAC, Art. No. 885500 35: Continuous current 35A, 480VAC, Art. No. 885506 </p>
	<p>Communication interface CI-USB-1 Art. No. 885650</p>
	<p>Temp. meter ATR- .</p> <p>  3: 300°C range, Art. No. 882130 5: 500°C range, Art. No. 882150 </p>

For more accessories: ↪ "Accessories" leaflet

13 Index

A

Accessories 11
 Actual value output 31
 Alarm output 12, 19, 36
 "ALARM-IN" signal 33
 Alloy 19, 21
 Ambient temperature 12
 Analog input 12
 Analog output 12
 Analog temperature meter 11
 Application 4
 Application Report 14
 AUTOCAL 21, 32
 Automatic zero calibration 21, 32
 Auxiliary voltage 12

B

Booster connection 36
 Burning in heatsealing band 20, 21

C

Celsius °C 34
 CI-USB-1 11, 36, 45
 Communication interface 11, 36, 45
 Controls 22
 Current transformer 11, 45
 Customer settings 44

D

Degree of protection 12
 Diagnostic interface 36
 Dimensions 13, 14
 Disable Configuration menu 34
 Display 23
 Display brightness 35

E

Error diagnosis 36

F

Factory settings 19, 43
 Fahrenheit °F 34
 Fault areas 41

H

Heatsealing band type 12

I

Installation 13, 14
 Installation procedure 14
 Installation regulations 14

L

Line filter 11, 45
 Line frequency 12
 Line voltage 12

M

Maintenance 44
 "MAN" key locked 33
 Maximum temperature set point 31
 Measurement cable 11
 Measuring range 12
 Modifications 11, 45
 MODs 11, 45
 Monitoring current transformer 11
 Monitoring temperature 31

P

PEX-W2/-W3 3
 PEX-W3 45
 Power dissipation 12
 Power supply system 12
 Principle 5

R

Replacing heatsealing band 20
 Replacing the heatsealing band 21
 "RESET" signal 33
 Rotary coding switch 35, 43

S

Standby mode 35
 System diagnosis 36
 System monitoring 36

T

TCR 3, 20
 Temperature coefficient 3, 19, 20
 Temperature meter 11, 31, 32, 45
 Temperature range 12, 19
 Temperature unit 34
 Transformer 3
 Type of construction 12

U

Undervoltage detection 35
 Unit configuration 18

V

View of the unit 18
 Visualization software 36

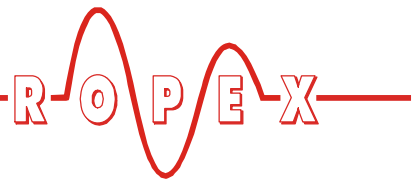

W
Wiring 14

Wiring diagram 17